

Dr.Engrave

USER'S MANUAL

This document is the operation manual for Dr. Engrave for Windows, a program for plate engraving.

Contents

Introduction	4	Importing bitmap data	31
Operating environment	5		
Overview of Dr.Engrave	5	Commands	32
Starting the software	6	Toolbar buttons	33
Names and functions of screen items	7	Commands - [File] menu	34
Operation Procedures	8	[File] - [New...] command	34
Introduction	9	[File] - [Open...] command	34
Step 1: Enter the workpiece size	9	[File] - [Save] command	34
Step 2: Set the cutting conditions	10	[File] - [Save As...] command	34
Step 3: Enter the text	10	[File] - [Import...] command	34
Step 4: Draw graphics	11	[File] - [Import Text...] command	35
Step 5: Import an image file	11	[File] - [Select Source] command	35
Step 6: Save the file	12	[File] - [Acquire...] command	35
Step 7: Start engraving	12	[File] - [Print...] command	35
		[File] - [Print Preview] command	35
		[File] - [Print Setup...] command	35
		[File] - [Preferences...] command	36
		[File] - [Exit] command	36
Basic Operations for Objects	13	Commands - [Edit] menu	37
Selecting an object	14	[Edit] - [Undo] command	37
Canceling the selection of an object	14	[Edit] - [Redo] command	37
Moving an object horizontally or vertically	14	[Edit] - [Cut] command	37
Making an object larger or smaller	14	[Edit] - [Copy] command	37
Rotating an object	14	[Edit] - [Paste] command	37
Slanting an object	15	[Edit] - [Delete] command	37
Copying an object	15	[Edit] - [Select All] command	37
Deleting an object	15	Commands - [View] menu	38
Selecting a vertex of a polygon (polyline)	15	[View] - [Zoom] - [Zoom In] command	38
Selecting multiple vertices of a polygon (polyline)	15	[View] - [Zoom] - [Zoom Out] command	38
Selecting all vertices of a polygon (polyline)	16	[View] - [Zoom] - [Custom...] command	38
Moving a vertex of a polygon (polyline) horizontally		[View] - [Fit to Screen] command	38
or vertically	16	[View] - [Toolbar] command	38
Adding a vertex to a polygon (polyline)	16	[View] - [Object Info.] command	38
Deleting a vertex of a polygon (polyline)	16	[View] - [Status Bar] command	38
		[View] - [Layout Info.] command	38
		[View] - [Guide Lines] command	39
		[View] - [Show Grid] command	39
		[View] - [Snap To Grid] command	39
		[View] - [Grid Setup...] command	39
Hints and Tips	17	Commands - [Format] menu	40
About the origin point for engraving	18	[Format] - [Font...] command	40
Changing the engraving depth	18	[Format] - [Style] command	40
Arranging plates of the same size for engraving at one time	19	[Format] - [Direction] command	40
Dividing a single plate to create multiple plates	22	[Format] - [Line Alignment] command	40
Re-engraving a desired plate	25	[Format] - [Line Spacing] command	40
Importing a text file into a text box	25	[Format] - [Character Spacing] command	40
Speeding up text engraving	26	[Format] - [Make Stroke...] command	40
Creating shapes (such as circles and squares) with a vertical/ horizontal aspect of 1:1	26	[Format] - [Edit Stroke...] command	41
Changing the size without altering the centerpoint	26	[Format] - [Properties...] command	41
Starting drawing of a graphic from a centerpoint	27	Commands - [Shape] menu	42
Creating regular polygons	27	[Shape] - [Properties...] command	42
Aligning the centers of a number of objects	27	[Shape] - [Fill] command	48
Arranging a number of objects -Using Snap to Grid-	28	[Shape] - [Move Shape...] command	49
Pasting a graphic created with commercial software	28	[Shape] - [Mirror] command	49
Using symbols	29	[Shape] - [Convert to Polygon] command	49
Changing the Measurement System for Numerical Values	29	[Shape] - [Combine Polygons] command	49
Using a scanner to import an object	30	[Shape] - [Break Apart] command	50

[Shape] - [Insert Vertex] command	50
[Shape] - [Delete Vertex] command	50
[Shape] - [Connect Vertex] command	50
[Shape] - [Server Vertex] command	50
[Shape] - [Snap to Vertex] command	50
[Shape] - [Symbols] command	51
[Shape] - [Add Symbol] command	51
Commands - [Layout] menu	52
[Layout] - [Layout Setup] command	52
[Layout] - [Edit Template] command	52
[Layout] - [Return to Layout] command	52
[Layout] - [Move To Front] command	52
[Layout] - [Move To Back] command	53
[Layout] - [Align] command	53
Commands - [Help] menu	53
[Help] - [Contents] command	53
[Help] - [About Dr.Engrave...] command	53

If You Think There's a Problem 54

If You Think There's a Problem	55
Error Messages	55
Other symptoms	56

Appendixes 58

Operating Procedures of SFEEdit	59
1 Names and functions	59
2 Operation Procedures	60
Step1: Choose the text	60
Step2: Correct the shape of the character	60
Step3: Save the file	61
3 Basic Operations	62
4 Commands	65
Toolbar buttons	65
Commands - [File] menu	66
Commands - [Edit] menu	68
Commands - [View] menu	69
Commands - [Shape] menu	70
Commands - [Help] menu	72
5 Error Messages	73
Glossary	74
Index	75

Windows® and Windows NT® are registered trademarks or trademarks of Microsoft® Corporation in the United States and/or other countries.
TrueType is a trademark of Apple Computer, Inc.
Corel Draw is a trademark of Corel Corporation.



Introduction

Operating environment

Computer

Personal computer running Windows 95, Windows 98, or Windows NT® 4.0

CPU

If you're using Windows 95:

i486SX or better (Pentium 100 MHz recommended)

If you're using Windows 98 or Windows NT 4.0:

i486DX or better (Pentium 100 MHz recommended)

System Memory

If you're using Windows 95:

8 MB or more (10 MB or more recommended)

If you're using Windows 98 or Windows NT 4.0:

16 MB or more (32 MB or more recommended)

Hard Disk

10 MB or more of free space

Overview of Dr. Engrave

Dr. Engrave is a program for plate engraving that runs under Windows 95/98/NT.

Main Features of Dr. Engrave

- Support for multiple plates
You can arrange a number of plates with the same design within the engraver's cutting area. This makes it possible to make many plates efficiently.
You can make a master plate, then make the settings for the number of plates laid out and their spacing. You can also divide a single plate.
- Import text files
Text files with comma- or tab-separated values can be imported into text boxes. This lets you make use of files made using a spreadsheet or a database that can export data in text format.
- Fill feature
Flat-drag machining can be performed for the center of text and graphics.
- Image contouring
Image contours can be extracted and converted to line segments.
Images can be entered by [importing them from a TWAIN-compliant image scanner](#) connected to the host computer, or by [importing an image file saved in bitmap \(BMP\) format](#).
You can also register a converted graphic as a symbol.
- Generation of stroke characters
Characters with no line width (i.e., stroke characters) can be generated automatically from [TrueType font](#) characters. You can use such generated stroke fonts in Dr. Engrave in the same way as other fonts registered with Windows. (However, you can't use them with other programs.)
Text that has been changed to stroke characters can be [engraved more rapidly than outline fonts](#), because the characters are made up of fewer line segments.
You can also clean up such automatically generated stroke characters (stroke-character edit function).
- You can extract and display the contours of characters (for TrueType fonts).
- You can set characters (TrueType fonts) to the desired width (weight).
- You can create rectangles, circles, stars, polygons (polyline), and other graphics.
- Objects can be positioned with precision (snap-to-grid feature).

Starting the software

1. Click [Start].
Point to [Roland Dr.Engrave] and click [Dr.Engrave].

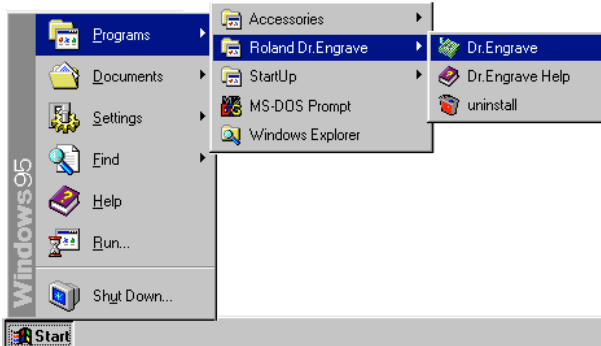

2. The opening screen appears and Dr.Engrave starts.

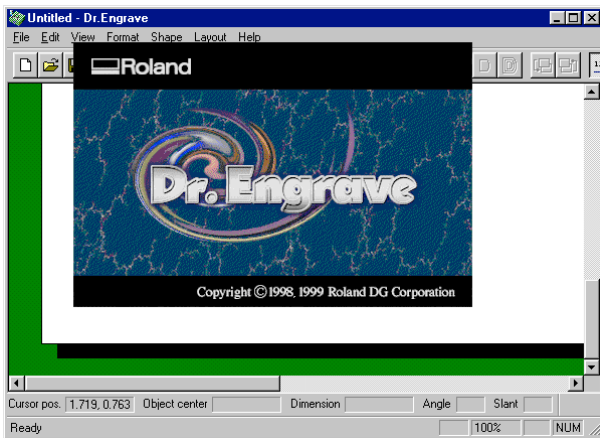

Names and functions of screen items

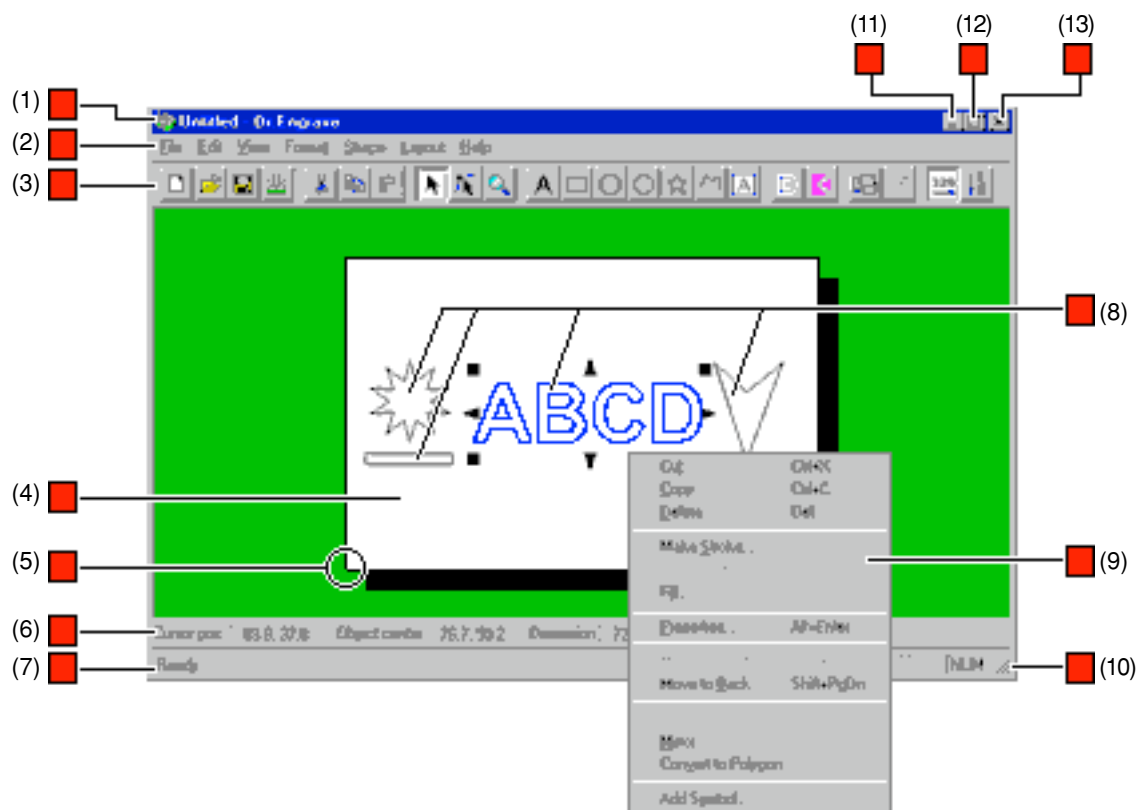

(1) Title bar

The file name and program name are displayed here. The window can be moved by dragging the title bar.

(2) Menu Bar

Runs the various commands for Dr.Engrave.

(3) Toolbar

The toolbar is provided with buttons for running Dr.Engrave commands such as [Open...] and [Save]. Moving the mouse pointer over a button displays a brief description of the button's function.

(4) Engraving area

This white square shows the engraving area (cutting area) set with the driver.

An object that protrudes beyond this area is not engraved.

The lower-left point of the engraving area is the origin point for Dr. Engrave, which coincides with the XY origin (home position) of the engraving machine.

(5) Origin point

This point (the lower-left point of the engraving area), is the origin point for Dr. Engrave.

This coincides with the XY origin (home position) for the engraving machine.

(6) Object Information Bar

This shows the location of the mouse pointer, as well as the centerpoint, size, angle, and slant of the object.

This doesn't appear when more than one plate is laid out.

(7) Status Bar

This shows Dr. Engrave's state of operation and provides brief descriptions of commands.

This also shows line color and amount of zoom in or zoom out for the image.

(8) Object

This is a shape or a block of text to be engrave.

(9) Popup menu

Clicking the right mouse button within an editing area makes a menu appear.

The displayed menu varies according to the type of selected object or present mode.

(10)

When the mouse pointer is moved close to here, the pointer changes to a diagonal arrow. You can then change the window size by dragging.

(11) Minimize button

This shrinks the window to a button on the taskbar.

(12) Maximize button

This expands the window to fill the screen.

(13) Close button

This ends the program.

If changes made to the file being edited have not been saved, a dialog box asking if you wish to save the changes is displayed.

1



**Operation
Procedures**

Introduction

This section explains the basic operation of Dr. Engrave, taking the engraving of the plate shown in the figure as an example to describe each step.

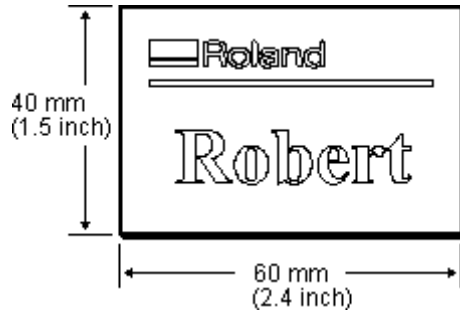

Step 1: Enter the workpiece size

Set the engraving area to match the size of the workpiece loaded. The engraving range that has been set becomes the editing area for Dr. Engrave. The editing area is represented by a shadowed white rectangle.

A plate is designed by arranging shapes and text in the editing area. Portions that extend beyond this area are not engrave.

1. From the [File] menu, click [Print Setup...].
The [Print Setup] dialog box is displayed.
2. For [Printer], click [Name], then choose the driver to be used for output.

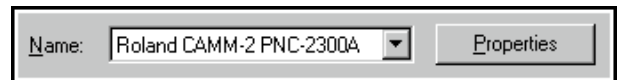

3. Click [Properties].
The driver's properties open.
4. Enter the cutting area (engraving area).
In this example, enter a range with vertical size of 40 mm and a horizontal size of 60 mm.

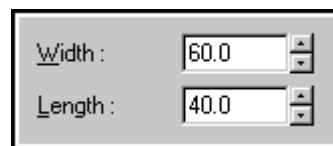

5. Leave the Properties screen displayed and carry out the next steps.

Step 2: Set the cutting conditions

Make the settings for the blade's movement speed, cutting-in amount, and other cutting conditions to match the composition and thickness of the loaded workpiece and the type of blade. For cutting conditions such as Z0 that can't be set with the driver, make the settings directly on the engraving machine. This section gives an overview of the steps when engraving all graphics and text at the same depth. For more details about the cutting-condition settings, see the help screens for the driver.

1. At the driver's Properties, click the [Tool] tab.
2. Enter the feed rate for [X/Y Speed] and [Z Speed].

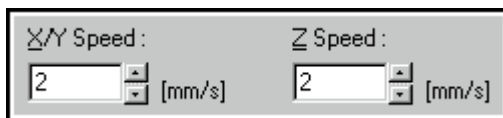

When the feeding speed is high, processing becomes rough and flash marks tend to remain on the cut surface. On the other hand, when the feeding speed is slow, processing takes more time.

Be careful because a slower feeding speed does not always result in improved finishing.

Set a feed rate that is optimal for the composition of the workpiece being engraved as well as the composition and diameter of the blade.

3. Enter the values for [Z Up Position] and [Z Down Position]. The figure below shows a case where Z0 is set at the workpiece surface.

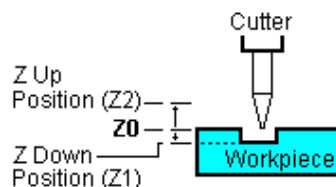
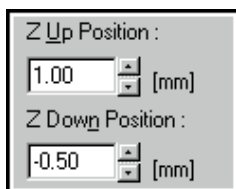

4. Enter the value for [Z Engraving Pitch].

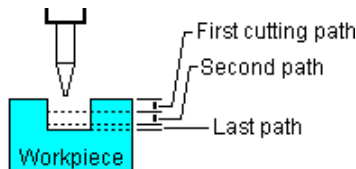
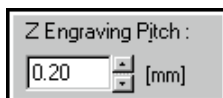

When the cutting-in amount is deeper, the cutting speed increases, but the cutting-in amount is limited by the quality of the workpiece. In cases where the required depth can not be cut at once, repeat cutting several times to depth that does not breach the limit.





5. Click [OK]. The click [OK] again to close the [Print Setup] dialog box.

Step 3: Enter the text

Enter the block of text to be engraved.

The text that is input is displayed as outlined text. Dr. Engrave can use **TrueType fonts** registered with Windows as well as stroke fonts that you create yourself.

Here we'll input Robert as the block of text and set Times New Roman.

1. Click the  button. The mouse pointer changes to the cursor for the text-editing tool ().
2. Click at the start point for entering the text.
3. Type in Robert from the keyboard.
4. Click the  button.
5. From the [Format] menu, click [Font...]. The [Font Select] dialog box is displayed.
6. Click on the font name to select it and click [OK]. Here, we'll select Times New Roman.
7. Drag one of the points () around the text string to change the size of the text string. To enlarge or reduce the size of the text string at a uniform scale, hold down the [Shift] key while dragging.
8. Drag the text string to position it at the desired location. In this example, the text string is positioned as shown the figure.

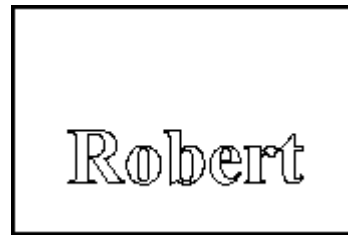



Step 4: Draw graphics

Add graphics to the data. In this example we'll draw a narrow rectangle.

In addition to regular rectangles, Dr. Engrave can draw rounded-corner rectangles, circles and ellipses, stars, and polygons (polyline).

1. Click the  button.

The mouse pointer changes from the selection tool () to the shape-drawing tool ().

2. Drag the pointer as shown in the figure.

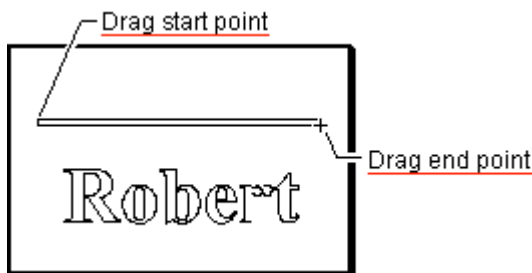

Step 5: Import an image file

You can import existing image data, extract the contours, and convert the data to line segments.

For instance, it's possible to include the logo data for a company or organization in a plate.

This section explains the steps in converting an image file you've already acquired with a scanner (in Windows bitmap format) to line segments.



1. From the [File] menu, click [Import...].
The [Open] dialog box appears.
2. Click [Files of type] and select [Windows Bitmap File (*.bmp)].

A list of files that can be imported is shown.

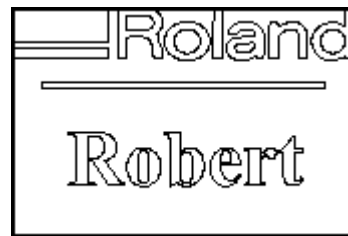

3. Select the desired file and click [Open].
4. The data is read into the preview screen and displayed. Check the contents and click [OK].
When importing a color image, outlining may not proceed as expected, depending on the colors. In such cases, drag the [Adjust Image Density] slider to adjust the image, or refer to the "Importing bitmap data" to correct the data using a commercial software application.
5. The outlined object appears on screen.



6. Click the  button.
7. Click on the object to select it.
8. Drag one of the points () around the object to change the size of the object.
To enlarge or reduce the size of the object at a uniform scale, hold down the [Shift] key while dragging.
9. Drag the object to position it at the desired location.
In this example, the object is positioned as shown the figure.

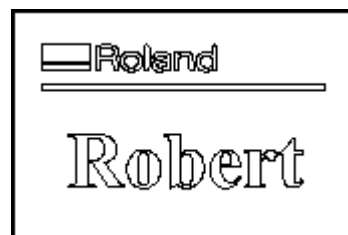

Step 6: Save the file

Save the data that's been created to a file.

1. Click the  button.
The [Save As] dialog box appears.
2. Specify where to save the file.
3. Enter the name of the file and click [Save].

Step 7: Start engraving

Output the data and start engraving.

Before starting engraving, check the cable connections, the loaded position of the workpiece, the installed blade, and the setting for the origin. For more information, take a look at the user's manual for the engraving machine.

1. Click the  button.
The [Print] dialog box appears.
2. Click [OK].
The engraving data is sent to the engraving machine, and engraving starts.



To cancel engraving before it's finished

1. Pause the engraving machine.
For more information, take a look at the user's manual for the engraving machine.
2. On the Windows, click [Start].
3. Point to [Settings] and click [Printers].
4. Double-click the icon for the printer driver.
5. From the [Printer] menu, click [Purge Print Jobs].
The file being engraved is deleted from the list. If the file being engraved isn't shown, it means that the sending of data has already ended.
6. Operate the engraving machine to end the task.
For more information, take a look at the user's manual for the engraving machine.

2

Basic Operations for Objects

Selecting an object

1. Click the  button.
2. Move the mouse cursor to the object to be selected, and click the mouse.
3. The symbols  and  appear around the selected object. When an object is chosen, pressing the [Tab] key selects a



different object. To invert the object selection order, hold down the [Shift] key and press [Tab].

Selecting more than object

- While holding down the [Shift] key, click on each of the objects you wish to select.
- Drag the mouse to enclose entirely the object you wish to select.



Canceling the selection of an object

1. Click the  button.
2. Click on an area other than the selected object.

Moving an object horizontally or vertically

1. Click the  button.
2. Click on the object to select it.
3. While holding down the [Shift] key, drag the object up, down, or to the left or right.

Making an object larger or smaller

1. Click the  button.
2. Click on the object to select it.
3. Change the size of the object by dragging the points ( and ) that appear around the object.

The size can be freely changed by dragging a square point ().

The size can be changed while maintaining the shape's vertical and horizontal aspect by holding down the [Shift] key while dragging.

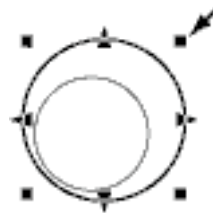



The triangular points () on the left and right can be dragged to change the horizontal size.



The triangular points () above and below can be dragged to change the vertical size.



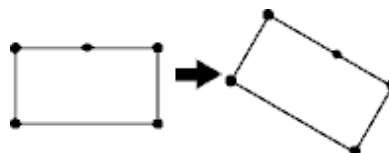

Rotating an object

1. Click the  button.
2. Click on the object to select it.
3. Click on the object again. The circular points () appear around the object.
4. Drag a circular point () to rotate the object.



Slanting an object

* Text boxes cannot be slanted.



1. Click the  button.
2. Click on the object to select it.
3. Click on the object again.
The diamond point () appears.
In the case of a text string, a slant bar appears.
4. Drag a diamond point () to slant the object.



For a text string, drag one of the points () for the slant bar.





Copying an object

1. Click the  button.
2. Select the object to be copied by clicking on it.
3. Click the  button.
4. Click the  button.
The new object is copied overlapping the source object.
5. Select the copied object and drag it to the desired location.



Deleting an object

1. Click the  button.
2. Select the object to be deleted by clicking on it.
3. From the [Edit] menu, click [Delete].

Selecting a vertex of a polygon (polyline)

1. Click the  button.
2. Click on the polygon (polyline).
3. Click on the point.
The selected point changes to a square with a border ().
When a vertex is chosen, pressing the [Tab] key selects a different vertex. To invert the vertex selection order, hold down the [Shift] key and press [Tab].

Selecting multiple vertices of a polygon (polyline)

1. Click the  button.
2. Click on the polygon (polyline).
3. Hold down the [Shift] key and click on each point ().
Alternatively, drag the mouse over the points to be selected.
Each selected point changes to a square with a border ().

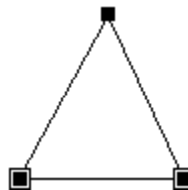

Selecting all vertices of a polygon (polyline)

1. Click the  button.
2. Click on the polygon (polyline).
3. While holding down the [Ctrl] key, click on one point (■). All vertices contained in the polygon (polyline) change to squares with borders (▣).

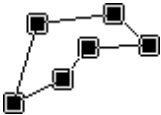

Moving a vertex of a polygon (polyline) horizontally or vertically

1. Click the  button.
2. Click on the polygon (polyline).
3. Hold down the [Shift] key and drag the vertex (■) up, down, or to the left or right.

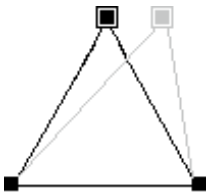

Adding a vertex to a polygon (polyline)

1. Click the  button.
2. Click on the polygon (polyline).
3. Move the mouse pointer over a line of the polygon, then click. A (□) appears where the point will be added.
4. From the [Shape] menu, click [Insert Vertex].

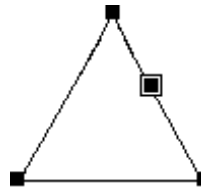

You can also double-click on a line in a graphic and add a vertex.

Deleting a vertex of a polygon (polyline)

1. Click the  button.
2. Click on the polygon (polyline).
3. Click on the point. The selected point changes to a square with a border (▣). To delete two or more points at the same time, hold down the [Shift] key as you click on each point (■). Alternatively, drag the mouse over the points to be deleted.
4. From the [Shape] menu, click [Delete Vertex].

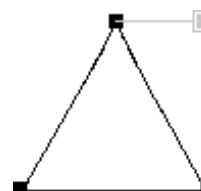

3



Hints and Tips

About the origin point for engraving

The following figure shows the origin point for Dr. Engrave. The location of the origin point is always at the lower-left point of the engraving area, and cannot be changed.

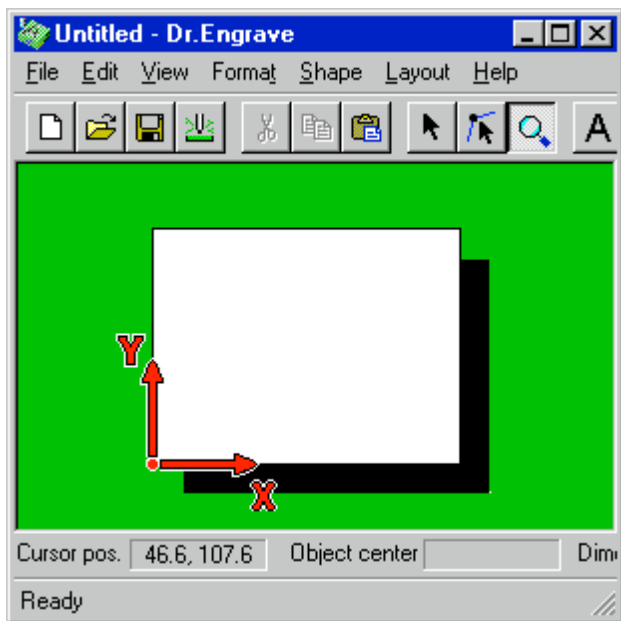

The origin point for Dr. Engrave coincides with the XY origin (home position) of the engraving machine.

Changing the engraving depth

To change the depth of engraving for each object, change the line (or fill) color.

The depths of the various colors can be set with the driver for the engraving machine. For more information about how to make the settings, see the help screens for the driver.

To change an object's line (or fill) color, follow the steps below.

1. Click the  button.
2. Click on the object to select it.
3. From the [Shape] menu, click [Properties].
The Properties dialog box for the selected object appears.
4. Click the drop-down arrow next to [Color], then click the desired color.

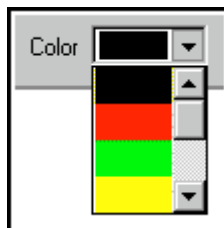

Related Topics

- [Text String Properties](#)
- [Shape Properties](#)
- [Polygon Properties](#)
- [Text Box Properties](#)

Arranging plates of the same size for engraving at one time

This section describes how to line up cut plates of the same size on the engraving machine's cutting table and engrave them at one time.

In this section, four plates measuring 60 mm x 40 mm (2.4 x 1.5 inch) are mounted on a base measuring 150 mm x 100 mm (6 x 4 inch), and the plates are changed to engrave a total of eight plates. To make it easy to understand, the procedure described here is broken down into three steps.

Step 1: Make a template file

Step 2: Arrange the plates and enter the text

Step 3: Ready the engraving machine and start engraving

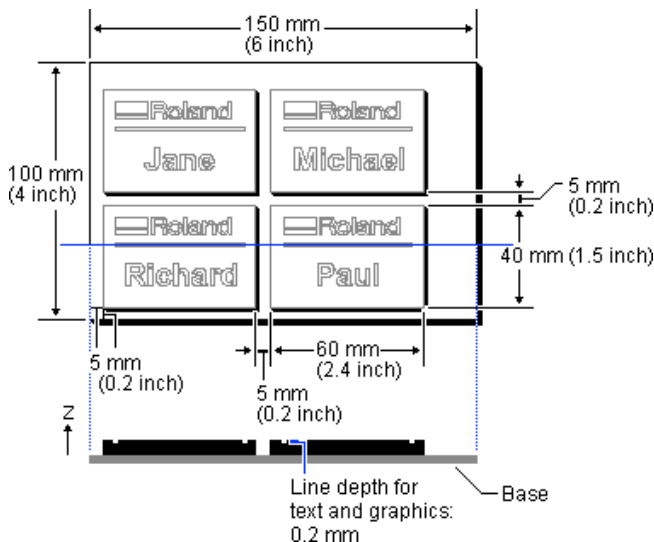

Step 1: Make a template file

Create the data for a single plate and save it as a template file.

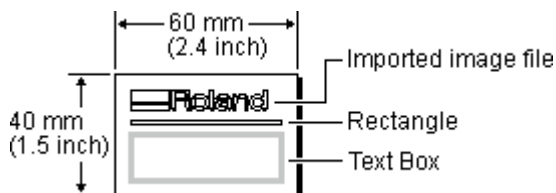

1. From the [File] menu, click [New...].
The [New File] dialog box appears.
2. Click the [Standard] tab, then click [New File].



3. Click [Template] to activate it, then click [OK].

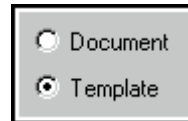

The [Template Properties] dialog box appears.

4. Enter the plate size, then click [OK].
In this example, enter the values shown below.

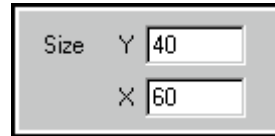

An empty file with no entries is opened.

5. Click  and create the text box shown in the figure.

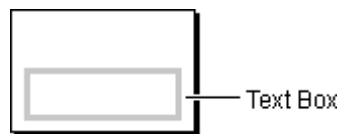

6. Make the settings for the size of the text in the text box, the font type, and so on.
You can also make the settings after laying out the plates. In that case, from the [Layout] menu, use [Edit Template]. In this example, the text settings are made ahead of time.
Choose a text box, then from the [Shape] menu, click [Properties].
7. Make the settings for the text size and layout, font type, and other necessary items, then click [OK].
Normally, you should set the size of the text so that it doesn't exceed the size of the text box.
8. Click  to make the rectangle shown in the figure.

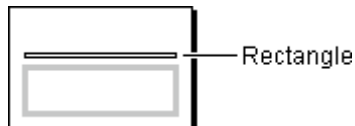

9. Import the image file shown in the figure.
For more information, see [Importing bitmap data](#) or [Using a scanner to import an object](#).

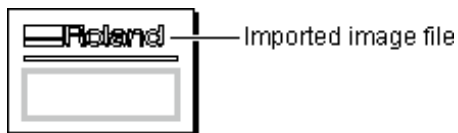

10. Click  and save the file.

Step 2: Arrange the plates and enter the text

Arrange the plates you created in Step 1, then enter the text in the text box.

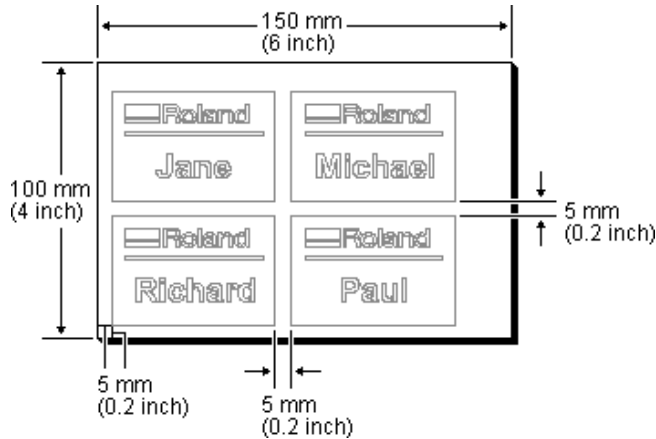

1. From the [Layout] menu, click [Layout Setup]. The [Layout Setup] dialog box appears.
2. Make the settings as shown in the figure, then click [OK].

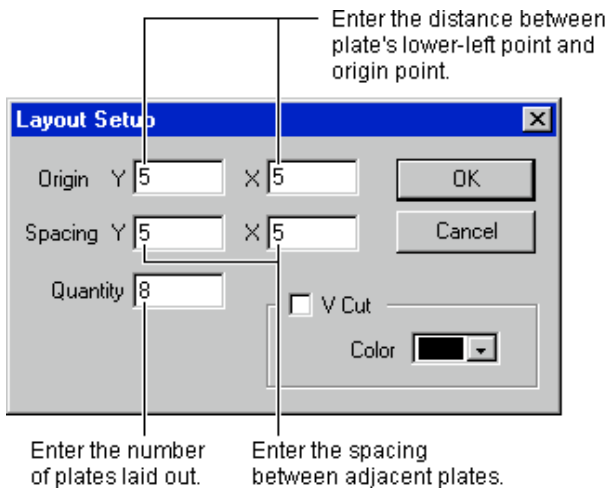

3. Enter the size of the base where the plates are mounted. From the [File] menu, click [Print Setup...]. The [Print Setup] dialog box appears.
4. Click [Properties]. The driver's properties open.
5. Enter the size of the base in the engraving area, then click [OK]. In this example, enter the values shown below.

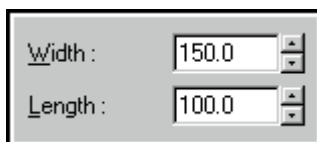

6. Click [OK] to close the [Print Setup] dialog box.
7. Click the **A** button.

8. Click on the text box and enter the text. In this example, enter the text shown below.

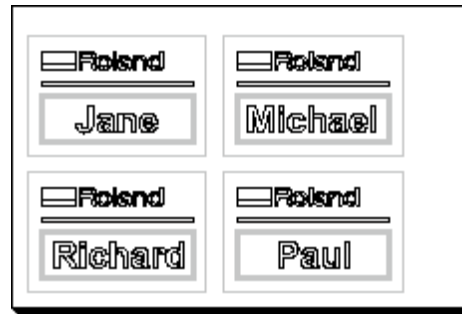

9. Click [Next] on the layout information bar to display the second page.

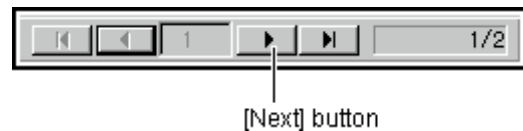

10. Click on the text box and enter the text. In this example, enter the text shown below.

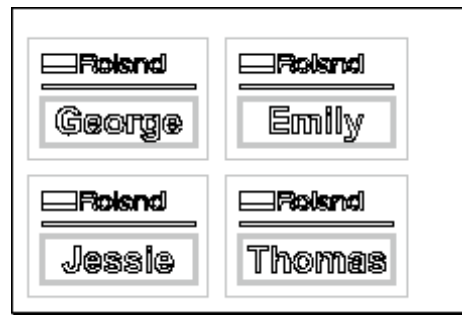

11. Click  and save the file.

Related Topics

[Importing a text file into a text box](#)

Step 3: Ready the engraving machine and start engraving

Install a blade and load a workpiece on the engraving machine, and start cutting.

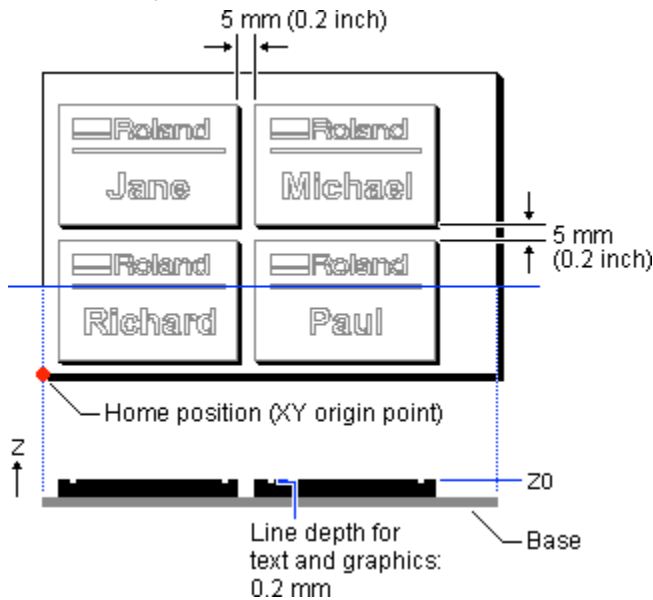

1. Install a blade and load a workpiece on the engraving machine.
Mount the base on the engraving machine's cutting table, and load the workpiece at the location shown in the figure. For more information, take a look at the user's manual for the engraving machine.

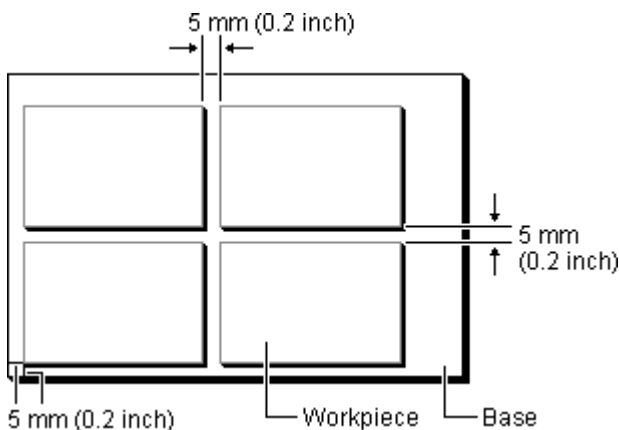

2. Operate the engraving machine to set Z0 at the surface of the workpiece.
Also, set the home position (XY origin point) at the lower-left point of the base.
For more information, take a look at the user's manual for the engraving machine.
3. Click the  button.
The [Print] dialog box appears.
4. Make the settings for the blade's movement speed, cutting-in amount, and other cutting conditions to match the composition and thickness of the loaded workpiece and the type of blade.
Click [Properties].
The driver's properties open.

5. Click [Tool] tab.

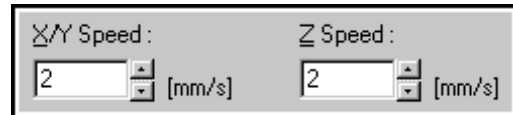

6. Enter the feed rate for [X/Y Speed] and [Z Speed].
When the feeding speed is high, processing becomes rough and flash marks tend to remain on the cut surface. On the other hand, when the feeding speed is slow, processing takes more time.
Be careful because a slower feeding speed does not always result in improved finishing.
Set a feed rate that is optimal for the composition of the workpiece being engraved as well as the composition and diameter of the blade.

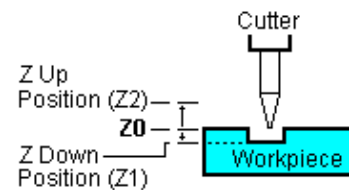
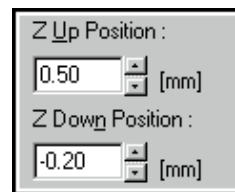

7. Enter the values for [Z Up Position] and [Z Down Position].

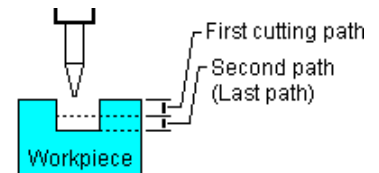
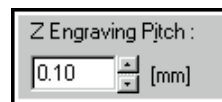

8. Enter the value for [Z Engraving Pitch].
When the cutting-in amount is deeper, the cutting speed increases, but the cutting-in amount is limited by the quality of the workpiece. In cases where the required depth can not be cut at once, repeat cutting several times to depth that does not breach the limit.
9. Click [OK] to close the driver's properties.
10. Click [OK].
The engraving data is sent to the engraving machine, and engraving starts.
11. When output of the first page of engraving data ends, a message appears to prompt you to change the workpiece.
Make sure the operation of the engraving machine has stopped, then load a new workpiece on the base. Load the workpiece in the same location as shown in the figure in 1 above. If necessary, set Z0 at the surface of the loaded workpiece again.
12. After loading the workpiece, click [OK].
The second page of engraving data is sent to the engraving machine, and cutting starts.

 **Related Topics**
[Re-engraving a desired plate](#)

Dividing a single plate to create multiple plates

This section describes how to place a single plate on the engraving machine's cutting table and engrave a number of plates while dividing the loaded plate.

In this section, four identical copies of a design measuring 60 mm x 40 mm (2.4 x 1.5 inch) are engraved on a plate measuring 150 mm x 100 mm (6 x 4 inch).

To make it easy to understand, the procedure described here is broken down into three steps.

Step 1: Make a template file

Step 2: Arrange the plates and enter the text

Step 3: Ready the engraving machine and start engraving

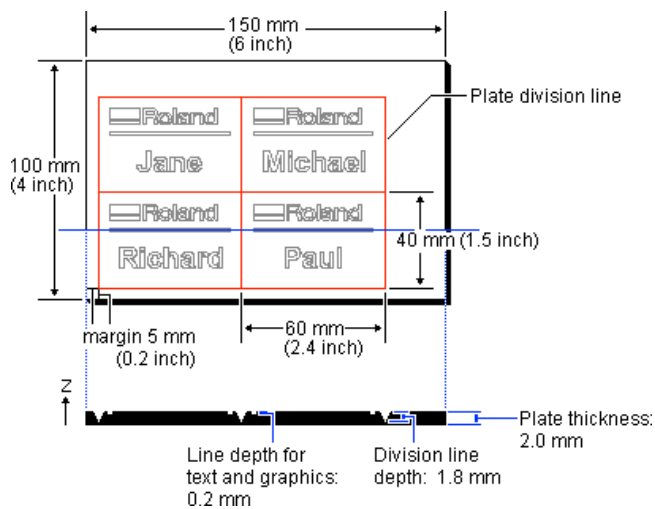

Step 1: Make a template file

Create the data for a single plate and save it as a template file.

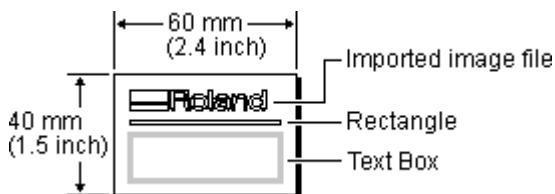

1. From the [File] menu, click [New...].
The [New File] dialog box appears.
2. Click the [Standard] tab, then click [New File].



3. Click [Template] to activate it, then click [OK].

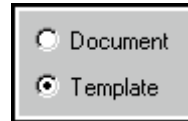

The [Template Properties] dialog box appears.

4. Enter the plate size, then click [OK].
In this example, enter the values shown below.

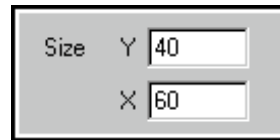

An empty file with no entries is opened.

5. Click  and create the text box shown in the figure.



6. Make the settings for the size of the text in the text box, the font type, and so on.
You can also make the settings after laying out the plates. In that case, from the [Layout] menu, use [Edit Template]. In this example, the text settings are made ahead of time.
Choose a text box, then from the [Shape] menu, click [Properties].
7. Make the settings for the text size and layout, font type, and other necessary items, then click [OK].
Normally, you should set the size of the text so that it doesn't exceed the size of the text box.
8. Click  to make the rectangle shown in the figure.



9. Import the image file shown in the figure.
For more information, see [Importing bitmap data](#) or [Using a scanner to import an object](#).

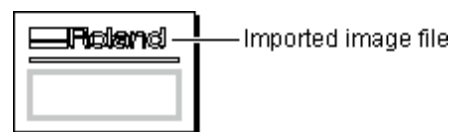

10. Click  and save the file.

Step 2: Arrange the plates and enter the text

Arrange the plates you created in Step 1, then enter the text in the text box.

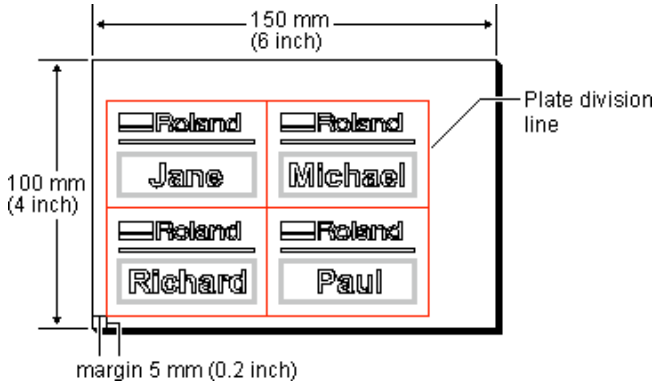

1. From the [Layout] menu, click [Layout Setup]. The [Layout Setup] dialog box appears.
2. Make the settings as shown in the figure, then click [OK].

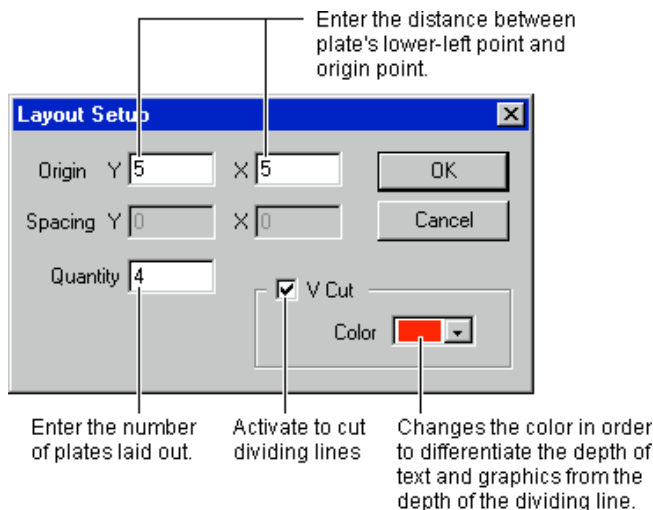

3. Enter the size of the entire plate to be engraved. From the [File] menu, click [Print Setup...]. The [Print Setup] dialog box appears.
4. Click [Properties]. The driver's properties open.
5. Enter the size of the plate in the engraving area, then click [OK]. In this example, enter the values shown below.

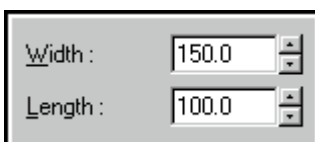

6. Click [OK] to close the [Print Setup] dialog box.
7. Click the **A** button.

8. Click on the text box and enter the text. In this example, enter the text shown below.

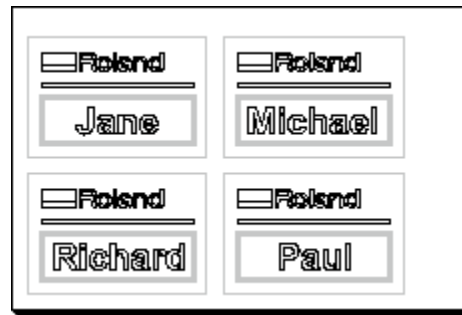

9. Click and save the file.

Related Topics

[Importing a text file into a text box](#)

Step 3: Ready the engraving machine and start engraving

Install a blade and load a workpiece on the engraving machine, and start cutting.

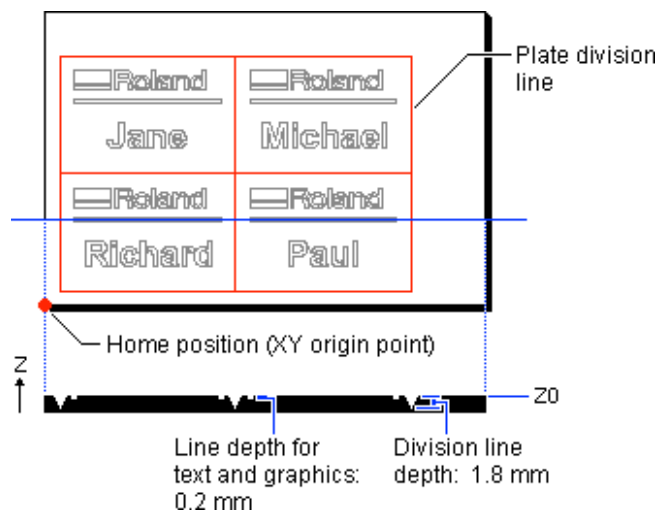

1. Install a blade and load a workpiece on the engraving machine. For more information, take a look at the user's manual for the engraving machine.
2. Operate the engraving machine to set Z0 at the surface of the workpiece. Also, set the home position (XY origin point) at the lower-left point of the workpiece. For more information, take a look at the user's manual for the engraving machine.
3. Click the button. The [Print] dialog box appears.

- Make the settings for the blade's movement speed, cutting-in amount, and other cutting conditions to match the composition and thickness of the loaded workpiece and the type of blade. Click [Properties].

The driver's properties open.

- Click [Tool] tab.
- The color of the graphic and text lines is set to black, and the color of the dividing lines is set to red.
- Set different cutting conditions for the respective colors.
- Click on a black tab and specify a tool number.



- Enter the feed rate for [X/Y Speed] and [Z Speed].

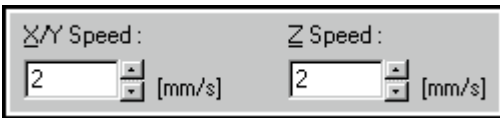

When the feeding speed is high, processing becomes rough and flash marks tend to remain on the cut surface. On the other hand, when the feeding speed is slow, processing takes more time.

Be careful because a slower feeding speed does not always result in improved finishing.

Set a feed rate that is optimal for the composition of the workpiece being engraved as well as the composition and diameter of the blade.

- Enter the values for [Z Up Position] and [Z Down Position].

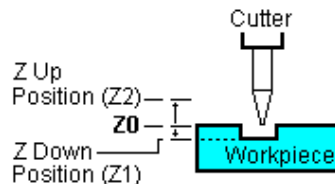
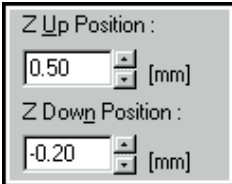

- Enter the value for [Z Engraving Pitch].

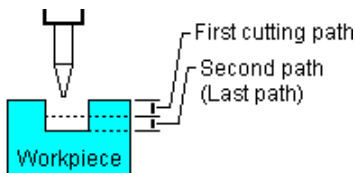

When the cutting-in amount is deeper, the cutting speed increases, but the cutting-in amount is limited by the quality of the workpiece. In cases where the required depth can not be cut at once, repeat cutting several times to depth that does not breach the limit.

- Set the cutting conditions for the dividing lines. Click on a red tab and specify a tool number.



- Make the settings for steps 8 through 11. For [Z Down Position], enter 1.8 mm.
- To replace the blade while engraving is PAUSE, activate [Pause for Tool Change].

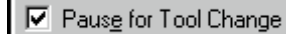

- Click [OK] to close the driver's properties.
- Click [OK]. The engraving data is sent to the engraving machine, and engraving starts.

Related Topics

[Re-engraving a desired plate](#)

Re-engraving a desired plate

This section describes how to re-engage a desired plate after laying out and engraving a number of plates.

At such times as when a portion of the engraving is unsuccessful, or when engraving is carried out without noticing that text entry has failed, you can select only the unsuccessful plate and carry out engraving again.

1. Open the desired file.
2. Click the page-selection buttons on the layout information bar to display the page that includes the plate you want to modify.

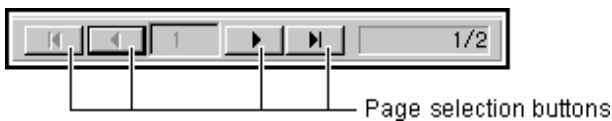

3. Correct the data.
4. Click the  button.
5. Click on the plate to be reworked.
The plate's contour is selected and its color changes to blue. To choose a number of plates, hold down the [Shift] key as you click on the plates.

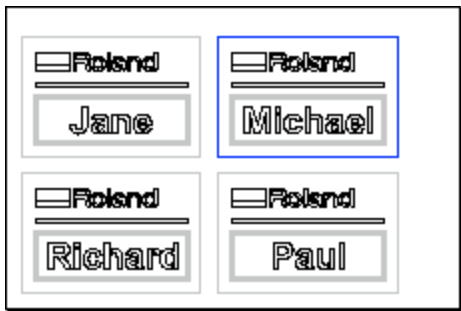

6. Install a blade and load a workpiece on the engraving machine.
For more information, take a look at the user's manual for the engraving machine.
7. Click the  button.
The [Print] dialog box appears.
8. For [Print range], activate [Pages] and specify the page range to be re-engraved.

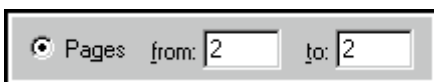

9. Click [OK].
The engraving data for only the specified plate is sent to the engraving machine, and engraving starts.

Importing a text file into a text box

This section how to take text data created with a spreadsheet or database and import it into a text box.

1. Use a spreadsheet or database to make a text file containing the data to be imported into the text box.
Choose commas or tabs as the field separators. Dr. Engrave cannot recognize any separators other than these. For more information, refer to the documentation for the spreadsheet or database.
2. Open a template file that contains a text box.
3. Make the settings for the size of the text in the text box, the font type, and so on.
You can also make these settings after importing the text. In that case, from the [Layout] menu, use [Edit Template]. In this example, the text settings are made ahead of time. Choose a text box, then from the [Shape] menu, click [Properties].
4. Make the settings for the text size and layout, font type, and other necessary items, then click [OK].
Normally, you should set the size of the text so that it doesn't exceed the size of the text box.
5. Click  and save the template file.
6. From the [Layout] menu, click [Layout Setup].
The [Layout Setup] dialog box appears.
7. Enter the necessary layout information.
It's not necessary to lay out the same number of plates as the number of records. The number of plates is adjusted to be the same as the number of records when the records are imported.
8. Click [OK].
The Template Layout mode is enabled.
9. From the [File] menu, click [Import Text...].
The [Open] dialog box appears.
10. Choose the text file you prepared in step 1, then click [OK].
The [Text Import] wizard appears.
11. Click on the field separator, then click [Next].
12. Specify the type of field data to import into the text box.
Drag the text in the field over the text box where you want to import it.
When you're done making the settings, click [Next].
13. Choose the record to import into the text box.
To import all records, click [Select All].
14. When you're done specifying records, click [Finish].
The data in the text file is entered in the text box.

Speeding up text engraving

Text that has been changed to stroke characters can be engraved more rapidly than outline fonts, because the characters are made up of fewer line segments.



1. Choose a text string to convert to stroke characters.
2. From the [Shape] menu, click [Make Stroke...]. The [Select Stroke Font] dialog box appears.
3. Click the drop-down arrow for [Stroke Font Name] and choose a font, then click [OK]. To register a new stroke font, click the text box and enter the name of the new font.
4. The text is laid out on screen as stroke characters.

Related Topics

[\[Format\] - \[Edit Stroke...\] command](#)

Creating shapes (such as circles and squares) with a vertical/horizontal aspect of 1:1

To create a shape with a vertical/horizontal aspect of 1:1, such as a circle or square, drag while holding down the [Shift] key. This function is not supported when creating text or a polygon.

1. Click the button for creating a rectangle, round rectangle, circle or ellipse, or star.
2. While holding down the [Shift] key, drag the object.



Related Topics

[Making an object larger or smaller](#)

[Text String Properties \[Keep Aspect for input\]](#)

[Polygon Properties \[Keep Aspect for input\]](#)

Changing the size without altering the centerpoint

To change the size without altering the position of its centerpoint, hold down the [Ctrl] key and drag an editing point (■ or ▲).

1. Select the object.
2. While holding down the [Ctrl] key, drag a point (■ or ▲). The size can be freely changed by dragging a square point (■). The size can be changed while maintaining the shape's vertical and horizontal aspect by holding down the [Shift] key while dragging.

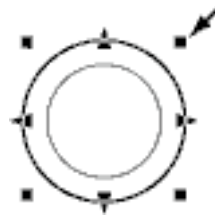

The triangular points (▲) on the left and right can be dragged to change the horizontal size.



The triangular points (▲) above and below can be dragged to change the vertical size.



Related Topics

[Making an object larger or smaller](#)

Starting drawing of a graphic from a centerpoint

To create a shape with a shape's start point the centerpoint, drag while holding down the [Ctrl] key. This function is not supported when creating text or a polygon.

1. Click the button for creating a square, rounded-corner square, circle or ellipse, or star.
2. While holding down the [Ctrl] key, drag the object.

Related Topics

[Creating shapes \(such as circles and squares\) with a vertical/horizontal aspect of 1:1](#)

Creating regular polygons

A regular polygon can be created by first making a circle, then modifying it.

1. Click the  button.
2. While holding down the [Shift] key, drag the mouse to create a circle.
3. Select the circle, then from the [Shape] menu, click [Properties]. The [Shape Properties] dialog box appears.
4. Drag the [Shape] slider.

You can make any regular polygon having from three sides (an equilateral triangle) to thirteen. Dragging the slider to the right-hand edge creates a circle instead of a polygon.

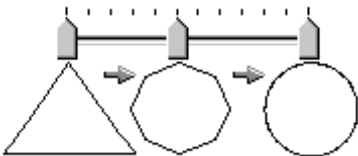

Aligning the centers of a number of objects

When arranging a text string at the center of a rectangle, or when create concentric circles, use the [Layout] menu's [Align] command.

1. Create the objects at any location.



2. [Select all of the objects](#) whose centers you wish to align.
3. From the [Layout] menu, click [Align]. The centers of the selected objects are aligned. If you have selected a number of objects while holding down the [Shift] key, the objects are overlaid atop the last object you chose. If you've selected a number of objects by dragging an area, the objects are overlaid atop the object in the foreground.



Related Topics

[Moving an object horizontally or vertically](#)

[Arranging a number of objects -- Using Snap to Grid](#)

Arranging a number of objects -Using Snap to Grid-

It's possible to use a grid as a guide for placing and sizing objects. The grid is shown on screen with equal vertical and horizontal spacing. When Dr. Engrave has just been installed, the grid is not shown.

To align an object with the grid, from the [View] menu, activate [Snap To Grid].

1. Create the object at any location.
2. At the [View] menu, click [Show Grid] to activate it.
3. At the [View] menu, click [Snap To Grid] to activate it.
4. Select the objects one at a time, and move each object toward the grid at the desired location. The object is automatically pulled to the grid and aligned.

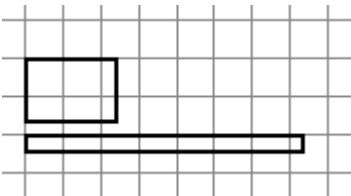

When the rectangles are aligned with the left-hand edge

Changing the point where an object snaps to the grid

The snap point is initially at an object's lower left.

To change the snap point, hold down the [Ctrl] key and click on the desired point.

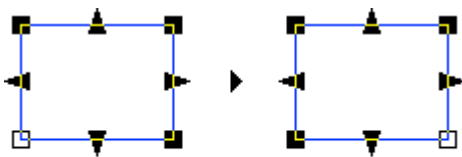

Click while holding down the [Ctrl] key.

The snap point can be a point around the perimeter of the object (any of eight points) or a point at the center of the object.



You can use this feature to align a number of objects at their centers or their upper-right points, for example.

Related Topics

[\[Grid Setup...\] command](#)

[Aligning the centers of a number of objects](#)

Pasting a graphic created with commercial software

You can copy data created with software such as CorelDRAW! that uses **vector data**, and paste the data into Dr. Engrave using the **clipboard**. The data pasted in can then be edited just like any ordinary object.

Conditions for data that can be pasted

- Don't include **bitmap data**
- Don't fill or apply shading inside shapes
- Set line width to the finest (narrowest) available setting

1. After using a commercial software application to create data, select the data and copy it. For information on how to create data with the commercial software application, refer to the documentation for the software you are using.
2. From the [Edit] menu, click [Paste]. The copied data appears in Dr. Engrave.

Using symbols

Dr. Engrave is provided with a set of symbols. Symbols can be added to a file being edited, or registered with Dr. Engrave objects.

Importing a symbol

1. From the [Shape] menu, click [Symbol].
The [Symbol] dialog box appears.
2. Select the group, then click on the symbol to be added.
3. Click [Insert].
The chosen symbol (object) is laid out on screen.
4. Adjust the size and position of the symbol to be placed.

Registering a symbol

1. Select the object to be registered a symbol.
2. From the [Shape] menu, click [Add Symbol].
The [Add Symbol] dialog box appears.
3. Register the symbol with an appropriate group according to use or shape.
To create a new group, click [New Group] and enter a name for the group. When adding the symbol to an existing group, select the group name with [Group Name].
4. At [Symbol Name], enter a name for the symbol. Then click [Add].

Changing the Measurement System for Numerical Values

The measurement system used for numerical values depends on the unit setting for Windows in effect when Dr. Engrave starts up. The settings for Windows can be changed with [Measurement System] on the [Number] tab under [Control Panel] - [Regional Setting].

If the measurement system has been changed, Dr. Engrave must be stopped and restarted for the new setting to take effect.

Using a scanner to import an object

An image acquired with a scanner can be imported into Dr. Engrave and outlined for engraving.

Dr. Engrave supports scanners that comply with TWAIN_32. For information on connecting the scanner and installing the scanner driver, please refer to the scanner's documentation.

There are some image whose outlines cannot be extracted. Please keep the following conditions in mind when creating data.

Conditions for data allowing extraction of clear outlines

- Boundaries between two colors should be sharp and well defined, with no continuous gradations.

Using only the two values of white and black is recommended. Scanned data for photographs generally contains continuous gradations, making it unsuitable for outlining.

<Example>



- The scan resolution should be high.

In general, a higher resolution yields outlining of greater accuracy. The optimal resolution varies according to a shape's complexity and size when cut. However, it takes longer to import high-resolution data into Dr. Engrave than low-resolution data.

<Example>

72 dpi

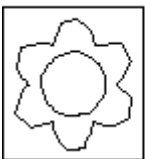

300 dpi



- The size of the original art being scanned should be the same as the size when engraving.

Results of engraving that are more attractive than the original art are not obtained when an image smaller than the engraved image is imported and then enlarged with Dr. Engrave. To help ensure attractive results of engraving, start with a larger object and reduce it to the desired size.

1. From the [File] menu, click [Select Source...].
2. Select the driver for the scanner.
If a TWAIN driver and a TWAIN_32 driver are both installed, select the TWAIN_32 driver.
3. Load the original document on the scanner.
4. From the [File] menu, click [Acquire...].
Launch the scanning software. For information on how to do this, please refer to the documentation for the scanner.
5. When the scanning is finished, the scanned data is imported into Dr. Engrave.
The [Preview] dialog box appears.
6. Check the scanned data in the [Preview] dialog box and click [OK].
7. The outlined object appears on screen.

Importing bitmap data

Dr. Engrave can import image files in **Windows bitmap** format (with a file extension of *.bmp), then outline (extract the contours) of the imported data or paste it as a polygon (polyline). For information on how to save a file in Windows bitmap format, please refer to the documentation for the software application.

There are some image whose outlines cannot be extracted. Please keep the following conditions in mind when creating data.

Conditions for data allowing extraction of clear outlines

- Boundaries between two colors should be sharp and well defined, with no continuous gradations.

Using only the two values of white and black is recommended. Scanned data for photographs generally contains continuous gradations, making it unsuitable for outlining.

<Example>



- The scan resolution should be high.

In general, a higher resolution yields outlining of greater accuracy. The optimal resolution varies according to a shape's complexity and size when cut. However, it takes longer to import high-resolution data into Dr. Engrave than low-resolution data.

<Example>

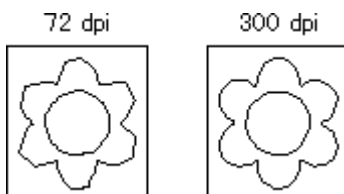

- The size of the original art being scanned should be the same as the size when engraving.

Results of engraving that are more attractive than the original art are not obtained when an image smaller than the engraved image is imported and then enlarged with Dr. Engrave. To help ensure attractive results of engraving, start with a larger object and reduce it to the desired size.

1. From the [File] menu, click [Import...].
The [Open] dialog box appears.
2. Click [Files of type] and select [Windows Bitmap File (*.bmp)].
A list of files that can be imported is shown. Select the desired file and click [Open...].
3. The data is read into the preview screen and displayed. Check the contents and click [OK].
When importing a color image, outlining may not proceed as expected, depending on the colors. In such cases, drag the [Adjust Image Density] slider to adjust the image, or refer to the "Conditions for data allowing extraction of clear outlines" to correct the data using a commercial software application.
4. The outlined object appears on screen.

Related Topics

[\[Import...\] command](#)

4



Commands

Toolbar buttons

The toolbar is provided with buttons for running Dr. Engrave commands such as [Open...] and [Save]. Moving the mouse pointer over a button displays a brief description of the button's function.



This creates a new file.



This opens a Dr. Engrave file.



This saves the file, overwriting the previous version of the file.



This takes the engraving data displayed on the edit screen and outputs it to the engraving machine.



This deletes the selected object, and copies it to the clipboard.



This copies the selected object to the clipboard.



This copies the contents of the clipboard, pasting them at the selected on-screen location.



This selects an object.



This is used to reposition the vertices of a polygon (polyline), changing its shape.



This enlarges or reduces the view of the object.



This is used to enter a block of text to be engrave.



This is used to create a square or rectangle by dragging to the desired location.



This is used to create a square or rectangle with rounded corners by dragging to the desired location.



This is used to create a circle or ellipse by dragging to the desired location.



This is used to create a star by dragging to the desired location.



This creates an open polygon (polyline) by clicking on vertices.



This creates an entry frame for text. This command is available only when editing a template file



This converts the selected text string to stroke characters.



This performs flat-drag engraving of the interior of a graphic or text.



The selected object is moved to the front.



The selected object is moved to the back.



The selected block text of text changes to a horizontal layout



The selected block text of text changes to a vertical layout.

Commands - [File] menu

[File] - [New...] command

This creates a new file.

Clicking the toolbar button creates a new document file empty of graphics or text strings. At the [File] menu, clicking [New] displays the [New File] dialog box.

If changes made to a file being edited have not been saved, a dialog box asking if you wish to save the changes is displayed.

 Keyboard shortcut: [Ctrl]+[N]

[New File] dialog box

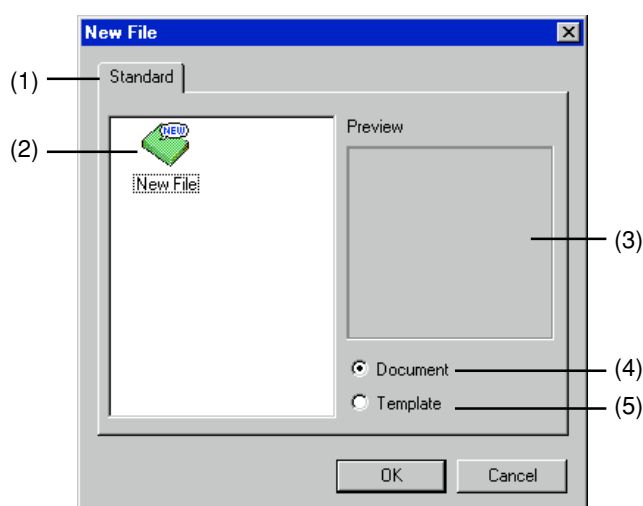

(1) Tab

The tab shows the group name for the template file.

The template files (*.det) in Dr. Engrave's [Template] folder appear on the [Standard] tab.

To add a new group, create another folder one level below the [Template] folder. The name of the folder you've created uses the tab name (group name) without change. Note that folders two or more levels below the [Template] folder are not displayed.

(2)

This displays a list of the template files included on the tab you selected.

To create a new file empty of graphics or text strings, at the [Standard] tab choose [New File].

To create a new document file (*.ded), make [Document] active. To create a new template file (*.det), make [Template] active.

(3) Preview

This displays the contents of the template file you've selected.

(4) Document

This copies the contents of the selected template file and creates a new document file.

To create a new document file (*.ded) empty of graphics or text strings, at the [Standard] tab choose [New File].

(5) Template

This copies the contents of the selected template file and creates a new template file.

To create a new template file (*.det) empty of graphics or text strings, at the [Standard] tab choose [New File].

[File] - [Open...] command

This opens a Dr. Engrave file.

Running this command opens the [Open] dialog box.

If changes made to a file being edited have not been saved, a dialog box asking if you wish to save the changes is displayed.

 Keyboard shortcut: [Ctrl]+[O]

[File] - [Save] command

This saves the file, overwriting the previous version of the file.

To save the file with a different name or in a different area, use the [Save As...] command.

 Keyboard shortcut: [Ctrl]+[S]

[File] - [Save As...] command

This saves the file with a different name.

Running this command opens the [Save As] dialog box.

[File] - [Import...] command

This imports a file created using another software application.

Running this command makes the [Open] dialog box appear.

Related Topics

[Importing bitmap data](#)

[File] - [Import Text...] command

This imports a comma- or tab-separated text file into a text box. This lets you make use of files made using a spreadsheet or a database that can export data in text format. This command is available only when multiple plates have been laid out.

Running this command displays the [Open] dialog box. Choose a file and click [OK] to call up the [Text Import] wizard. Follow the messages that the [Text Import] wizard shows to complete the procedure.

Related Topics

[Importing a text file into a text box](#)

[File] - [Select Source] command

This selects the scanner connected to the computer. Dr. Engrave supports scanners that comply with TWAIN_32. For information on connecting the scanner and installing the scanner driver, please refer to the scanner's documentation. If a TWAIN driver and a TWAIN_32 driver are both installed, choose the TWAIN_32 driver.

Related Topics

[Using a scanner to import an object](#)

[File] - [Acquire...] command

This takes in the image from the scanner. The acquired image is outlined and converted to graphics. Running this command launches the software for performing scanning. For more information on operation, please refer to the scanner's documentation.

Related Topics

[Using a scanner to import an object](#)

[File] - [Print...] command

This takes the engraving data displayed on the edit screen and outputs it to the engraving machine. Running this command opens the [Print] dialog box. To output data, then for [Printer], click on the down-pointing arrow next to [Name], then click on the driver to be used for output. At the [Print] dialog box you can make settings for the items such as the printing range and number of copies. To make settings for the engraving area (workpiece size) or the cutting conditions (tool speed, depth, and so on), click [Properties]. For more information on the Properties settings, refer to the help screens for the driver.

 Keyboard shortcut: [Ctrl]+[P]

[File] - [Print Preview] command

This displays what the results of printing will look like, so you can check your work before actually performing printing. Running this command changes the display from the object's edit screen to the preview screen.

Preview screen commands

Print...	This performs printing. The [Print] dialog box appears.
Page Setup...	This allows you to make settings for paper size, margins, and the like. The [Page Setup] dialog box appears.
Zoom In	This enlarges the view size of the print image.
Zoom Out	This reduces the view size of the print image.
Close	This closes the Preview screen for printing.

[File] - [Print Setup...] command

This is used to select the driver. The [Print Setup] dialog box appears. To output data, then for [Printer], click on the down-pointing arrow next to [Name], then click on the driver to be used for output. To make settings for the engraving area (workpiece size) or the cutting conditions (tool speed, depth, and so on), click [Properties]. For more information on the Properties settings, refer to the help screens for the driver. The settings made here are temporarily saved. The changes are lost when you quit Dr. Engrave.

[File] - [Preferences...] command

This sets the default font and text height when entering text, the screen color scheme, and the zoom ratio.

Running this command displays the [Preferences] dialog box.

[Preferences] dialog box

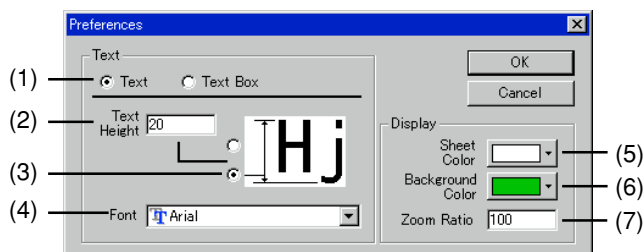

(1)
This chooses the default settings of the text string or the default settings of the text box.

(2) Text Height
This is for entering the default value for text height.

(3)
Choose the portion of the text for which you want to enter the height.

(4) Font
This sets the default font used when entering text.

(5) Sheet color
This determines the color of the engraving area.
To specify a color other than one of the selections shown, click [Other]. This displays the [Color] dialog box.

(6) Background color
This determines the background color for the engraving area.
To specify a color other than one of the selections shown, click [Other]. This displays the [Color] dialog box.

(7) Zoom ratio
This determines the zoom ratio used when Dr. Engrave starts.

[File] - [Exit] command

This ends the program.

If changes made to the file being edited have not been saved, a dialog box asking if you wish to save the changes is displayed.

▶ Shortcut:



Click the button for closing the application window.

Commands - [Edit] menu

[Edit] - [Undo] command

This erases the change just made and returns to the previous form.

 Keyboard shortcut: [Ctrl]+[Z]

[Edit] - [Redo] command

This cancels an [Undo] command that has just been run.

 Keyboard shortcut: [Ctrl]+[Y]

[Edit] - [Cut] command

This deletes the selected object, and copies it to the clipboard. The contents of the **clipboard** are maintained until another object is copied to the clipboard. To paste the clipboard contents, run the [Edit] - [Paste] command.

 Keyboard shortcut: [Ctrl]+[X]

[Edit] - [Copy] command

This copies the selected object to the clipboard. The contents of the clipboard are maintained until another object is copied to the **clipboard**. To paste the clipboard contents, run the [Edit] - [Paste] command.

 Keyboard shortcut: [Ctrl]+[C]

Related Topics

[Copying an object](#)

[Edit] - [Paste] command

This copies the contents of the clipboard, pasting them at the selected on-screen location.

 Keyboard shortcut: [Ctrl]+[V]

Related Topics

[Copying an object](#)

[Edit] - [Delete] command

This deletes the selected object. The deleted object is not copied to the clipboard.

 Keyboard shortcut: [Delete]

[Edit] - [Select All] command

This selects all objects displayed on screen.

 Keyboard shortcut: [Ctrl]+[A]

Commands - [View] menu

[View] - [Zoom] - [Zoom In] command

This displays an enlarged view of the object.

 Keyboard shortcut: [Ctrl]+[Page Down]

[View] - [Zoom] - [Zoom Out] command

This displays an reduced view of the object.

 Keyboard shortcut: [Ctrl]+[Page Up]

[View] - [Zoom] - [Custom...] command

This specifies the ratio for enlarging or reduced the view of the object.

Running this command opens the [Zoom Setup] dialog box. To set the zoom ratio used when Dr. Engrave starts, from the [File] menu, click [Preferences].

 Keyboard shortcut: [Ctrl]+[Page Up]

[Zoom Setup] dialog box

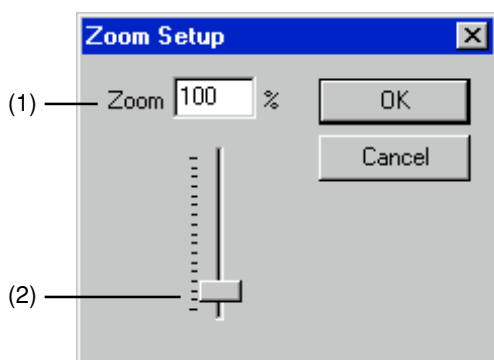

(1)
Enter the view ratio as a percentage.
Any integer from 1 to 800 can be entered.

(2)
Dragging this slider up or down changes the view ratio.
Any integer from 1 to 800 can be entered.

[View] - [Fit to Screen] command

This command expands or reduces the size of the object shown to fill the screen.

[View] - [Toolbar] command

This toggles the display of the toolbar on or off. The toolbar is provided with buttons for running Dr. Engrave commands such as [Open...] and [Save]. Moving the mouse pointer over a button displays the button's name. Toggling off the display of the toolbar enlarges the area of the edit screen.

Related Topics

[Toolbar buttons](#)

[View] - [Object Info.] command

This toggles the display of the object information bar on or off. The object information bar shows the position of the mouse pointer, as well as the object's centerpoint, dimensions, angle, and slant.

Toggling off the display of the object information bar enlarges the area of the edit screen.

[View] - [Status Bar] command

This command toggles display of the status bar window on or off. The status bar shows helpful comments amount commands. We recommend leaving the status bar on until you're familiar with how Dr. Engrave works. Turning off the status bar enlarges the object's display area.

[View] - [Layout Info.] command

This displays or hides the layout information bar. The layout information bar shows the position of the lower-left point (start point) of the plate laid out at the lower left, the spacing of adjacent templates, the presently displayed page, and the page feed buttons.

You can display or hide the layout information bar only when more than one plate is laid out. At this time, the object information bar does not appear. Turning off the layout information bar enlarges the object's display area.

[View] - [Guide Lines] command

This displays or hides the guide lines.

You can display or hide the guide lines only when more than one plate is laid out.

Using the guide lines, you can make these settings with the mouse:

The position of the lower-left point (start point) of the plate laid out at the lower left

The spacing between adjacent plates.

[View] - [Show Grid] command

This toggles the display of the grid on or off.

[View] - [Snap To Grid] command

When this is on, objects are automatically aligned with the grid lines.

Alignment with the grid lines can make it easier to arrange two or more objects and make settings for object size.

When Dr. Engrave has just been installed, this function is off.

The snap point is initially at an object's lower left.

To change the snap point, hold down the [Ctrl] key and click on the desired point.

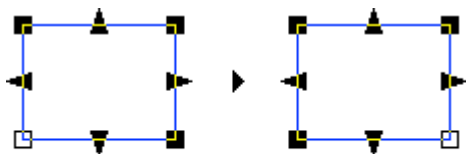

Click while holding down the [Ctrl] key.

The snap point can be a point around the perimeter of the object (any of eight points) or a point at the center of the object.

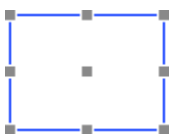

[View] - [Grid Setup...] command

This makes the settings for grid interval, whether the grid is displayed, and whether the snap to grid function is on or off.

Running this command displays the [Grid Setup] dialog box.

[Grid Setup] dialog box

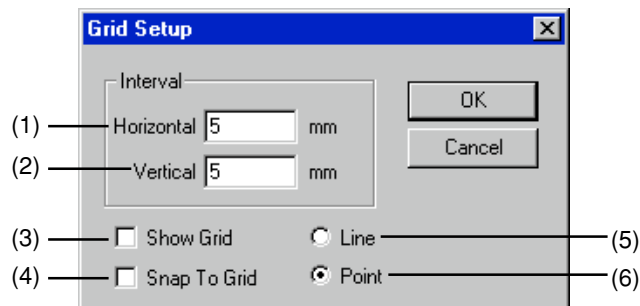

(1)

Enter the interval for horizontally adjacent grid lines.

When Dr. Engrave has just been installed, this is set at 5.0 mm (0.197 inch).

Setting range: 0 to 100 mm (0 to 4 inch)

Related Topics

[Changing the Measurement System for Numerical Values](#)

(2)

Enter the interval for vertically adjacent grid lines.

When Dr. Engrave has just been installed, this is set at 5.0 mm (0.197 inch).

Setting range: 0 to 100 mm (0 to 4 inch)

Related Topics

[Changing the Measurement System for Numerical Values](#)

(3)

This toggles the display of the grid on or off.

(4)

This toggles the function for snapping objects to the grid on or off.

(5)

The grid is shown with dotted lines.

(6)

The grid is shown with unbroken lines.

Commands - [Format] menu

[Format] - [Font...] command

This is used to select the font for a block of text. Running this command opens the [Font Select] dialog box. When a block of text has been selected, this command sets its font. When no text is selected, this command sets the font used when text is entered. To set the default font used when entering text, from the [File] menu, click [Preferences].

[Font Select] dialog box

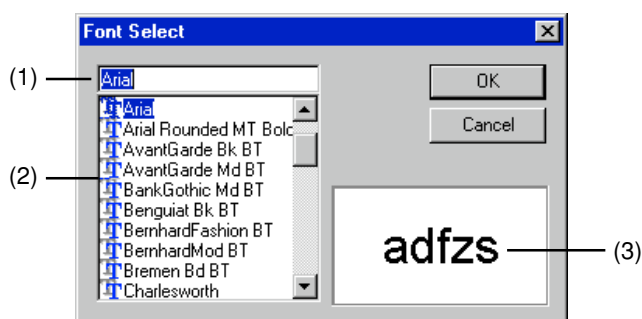

- (1) This displays the selected font. Choosing a font from the font list makes the display change. Clicking [OK] changes the font setting to the one displayed here.
- (2) This displays the fonts available for selection. Click on a font in the list to choose it. Dr. Engrave can use **TrueType fonts** registered with Windows as well as stroke fonts that you create yourself.
- (3) This displays the form of the selected font.

[Format] - [Style] command

This specifies a style (bold or italic) for a text string. To specify a setting other than line width or slant, click [Other]. The [Text String Properties](#) or [Text Box Properties](#) screen appears.

[Format] - [Direction] command

This setting determines whether the selected text is written vertically or horizontally.

[Format] - [Line Alignment] command

You can center a text string or align it with the left margin, the right margin, or both (justified). Also, for a text box, you can attach text above or below the box. You can also lay out text with proportional spacing in a text box. You can also make the settings from the [Text String Properties](#) or [Text Box Properties](#) screen.

[Format] - [Line Spacing] command

This specifies the spacing between adjacent lines. To specify a line spacing other than one of the available selections, click [Other]. The [Text String Properties](#) or [Text Box Properties](#) screen appears.

[Format] - [Character Spacing] command

This specifies the spacing between adjacent characters. To specify a character spacing other than one of the available selections, click [Other]. The [Text String Properties](#) or [Text Box Properties](#) screen appears.

[Format] - [Make Stroke...] command

This converts the selected text string to stroke characters. This extracts the centerlines of the characters and creates stroke characters. Running this command displays the [Select Stroke Font] dialog box.



Depending on the font, stroke characters may not be correctly aligned in horizontal rows or may not be converted to the character's originally designed line segments. In such cases, use the [Format] - [Edit Stroke...] command to correct the shape of the stroke characters.

[Select Stroke Font] dialog box

(1) Stroke Font Name



Choose a stroke font. To create a new stroke font, enter the font name in this text box.

[Format] - [Edit Stroke...] command

This corrects the shape of stroke characters.

This starts the program for editing stroke characters (SFEdit). The first character of the selected text string appears on the edit screen. For more on how to use SFEdit, See "[Appendixes - Operating Procedures of SFEdit-](#)".

[Format] - [Properties...] command

This is used to change the attributes and size of a text string or text box using numerical values.

When you've selected a text string, the [Text String Properties](#) screen appears. When you've selected a text box, the [Text Box Properties](#) screen appears.

Commands - [Shape] menu

[Shape] - [Properties...] command

This is used to change the form of an object by modifying its numerical values.

A dialog box for changing the shape appears. The items displayed vary according to the type of object selected.

Selecting a polygon (polyline) with three or more vertices displays the [Polygon Properties] screen. When there are two vertices, the [Straight Line Properties] screen appears.

To open the properties of a template, then while editing a template file, make sure no object is currently selected, and run this command.

[Text String Properties](#)
[Shape Properties](#)
[Polygon Properties](#)
[Straight Line Properties](#)
[Text Box Properties](#)
[Template Properties](#)

 Keyboard shortcut: [Alt] + [Enter]

[Text String Properties] dialog box

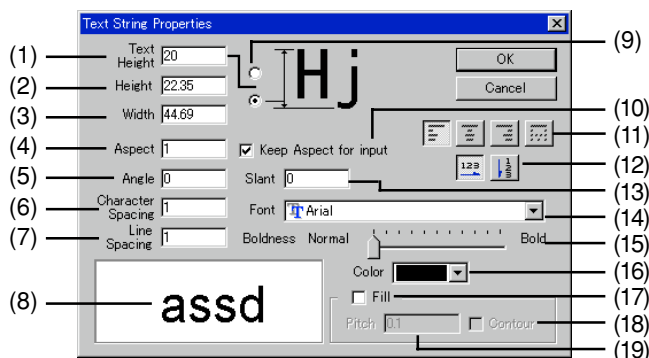

(1) Text Height

Enter the height of the text.

The setting immediately affects all characters in the text string. Changing this value also makes the [Height] value change accordingly.

 Related Topics

[Changing the Measurement System for Numerical Values](#)

(2) Height

Enter the overall height for the text string.

Changing this value also makes the [Text Height] value change accordingly.

 Related Topics

[Changing the Measurement System for Numerical Values](#)

(3) Width

Enter the overall width for the text string.

 Related Topics

[Changing the Measurement System for Numerical Values](#)

(4) Aspect

Enter the size as a ratio, with the vertical/horizontal aspect (vertical/horizontal ratio) when the text or shape was created as 1.

Entering a number changes the width without varying the height. Enter 2 to double the width. Enter 0.5 to halve it.

(5) Angle

Enter the angle of rotation for the object.

The unit is in degrees.

A negative angle may also be entered. Entering a negative angle rotates the object clockwise.

(6) Character Spacing

Enter the pitch (interval) for adjacent characters. Character size does not change.

Changing this value also makes the [Width] value change accordingly.

(7) Line Spacing

This specifies the spacing between adjacent lines.

(8)

This shows the shape of the text.

(9)

Choose the portion of the text for which you want to enter the height.

(10) Keep Aspect for input

This causes an object's aspect to be maintained at a fixed value when a numerical value is entered for Height or Width.

When a value is entered for Height (or Width), the value of Width (or Height) changes automatically.

(11) Line Alignment

You can center a text string or align it with the left margin, the right margin, or both (justified).

(12)

This setting determines whether the selected text is written vertically or horizontally.

(13) Slant

Enter the degree of slant of the object.

The unit is in degrees.

Entering a positive angle makes the object slant to the right.

Entering a negative angle makes the object slant to the left.

(14) Font

This displays the name of the selected font.

To change the font for the text, click on the down-pointing triangle.

(15) Boldness

Dragging the slider changes the thickness (weight) of text.

A font cannot be made narrower than its standard weight. The left-hand end of the slider is standard weight, and the right-hand end is maximum weight.

(16) Color

Choose the line color of the text or shape.

When [Fill] is on, this changes to the fill color.

Related Topics

[Changing the engraving depth](#)

(17) Fill

When on, the interior of the object (text or shape) is engraved by flat-drag cutting.

The route along which the tool moves (the tool path) is created along the contours of the object. Set the tool-path pitch with [Pitch].

The tool path is created on the inner side of the object. To engrave an object's contour lines, select [Contour].

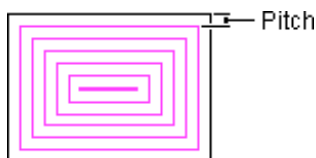
**(18) Contour**

After flat-drag engraving of the object finishes, the object's contours are engraved.

(19) Pitch

This sets the fill pitch (the spacing between adjacent tool paths).

Normally you should enter the diameter of the blade installed on the engraving machine. To ensure an attractive finish for flat-drag engraving, the pitch is generally set at a value smaller than the blade diameter.

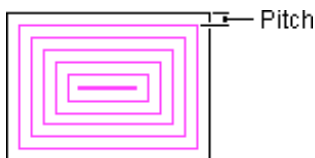
**Related Topics**

[Changing the Measurement System for Numerical Values](#)

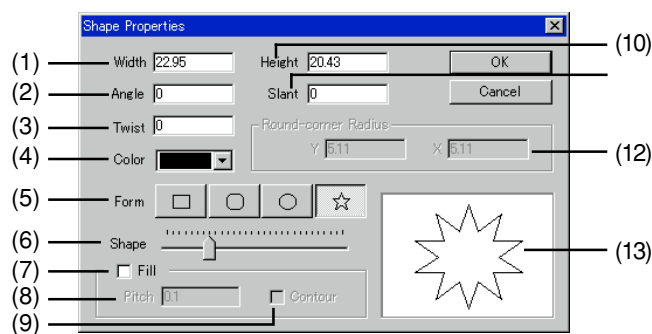
[Shape Properties] dialog box**(1) Width**

Enter the object's width.

Related Topics

[Changing the Measurement System for Numerical Values](#)

(2) Angle

Enter the angle of rotation for the object.

The unit is in degrees.

A negative angle may also be entered. Entering a negative angle rotates the object clockwise.

(3) Twist

This rotates the center of the star without change the positions of the vertices.

Enter the angle of rotation. The units of measurement are degrees.

Entering a positive value rotates the star counterclockwise.

Entering a negative value rotates it clockwise.

This can be used only with stars.

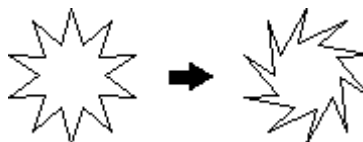
**(4) Color**

Choose the line color of the text or shape.

When [Fill] is on, this changes to the fill color.

Related Topics

[Changing the engraving depth](#)

(5) Form

Choose the type of shape.

(6) Shape

Drag the slider to change the shape of the object.

Depending on the type of shape you chose, the way the shape changes may vary.

(7) Fill

When on, the interior of the object (text or shape) is engraved by flat-drag cutting.

The route along which the tool moves (the tool path) is created along the contours of the object. Set the tool-path pitch with [Pitch].

The tool path is created on the inner side of the object. To engrave an object's contour lines, select [Contour].

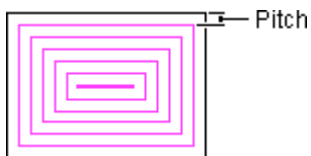
**(8) Pitch**

This sets the fill pitch (the spacing between adjacent tool paths).

Normally you should enter the diameter of the blade installed on the engraving machine. To ensure an attractive finish for flat-drag engraving, the pitch is generally set at a value smaller than the blade diameter.

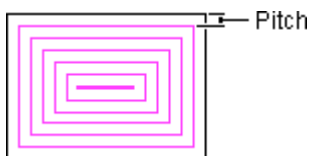
 **Related Topics**

[Changing the Measurement System for Numerical Values](#)

(9) Contour

After flat-drag engraving of the object finishes, the object's contours are engraved.

(10) Height

Enter the object's height.

 Related Topics

[Changing the Measurement System for Numerical Values](#)

(11) Slant

Enter the degree of slant of the object.

The unit is in degrees.

Entering a positive angle makes the object slant to the right.

Entering a negative angle makes the object slant to the left.

(12) Round-corner Radius

Enter the corner roundness for a rounded-corner rectangle.

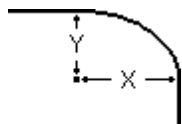
 **Related Topics**

[Changing the Measurement System for Numerical Values](#)

(13)

This shows the shape of the graphic.

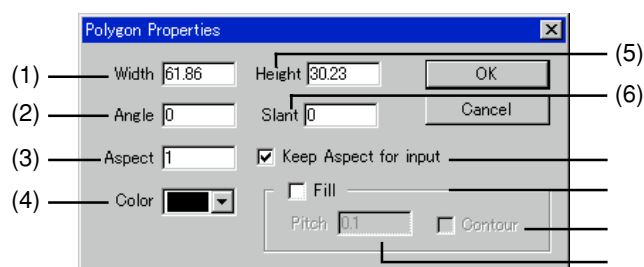
[Polygon Properties] dialog box**(1) Width**

Enter the object's width.

 Related Topics

[Changing the Measurement System for Numerical Values](#)

(2) Angle

Enter the angle of rotation for the object.

The unit is in degrees.

A negative angle may also be entered. Entering a negative angle rotates the object clockwise.

(3) Aspect

Enter the size as a ratio, with the vertical/horizontal aspect (vertical/horizontal ratio) when the text or shape was created as 1.

Entering a number changes the width without varying the height. Enter 2 to double the width. Enter 0.5 to halve it.

(4) Color

Choose the line color of the text or shape.

When [Fill] is on, this changes to the fill color.

 Related Topics

[Changing the engraving depth](#)

(5) Height

Enter the object's height.

 Related Topics

[Changing the Measurement System for Numerical Values](#)

(6) Slant

Enter the degree of slant of the object.

The unit is in degrees.

Entering a positive angle makes the object slant to the right.

Entering a negative angle makes the object slant to the left.

(7) Keep Aspect for input

This causes an object's aspect to be maintained at a fixed value when a numerical value is entered for Height or Width.

When a value is entered for Height (or Width), the value of Width (or Height) changes automatically.

(8) Fill

When on, the interior of the object (text or shape) is engraved by flat-drag cutting.

The route along which the tool moves (the tool path) is created along the contours of the object. Set the tool-path pitch with [Pitch].

The tool path is created on the inner side of the object. To engrave an object's contour lines, select [Contour].

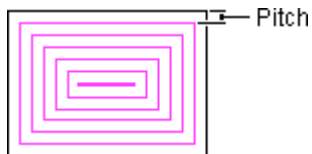
**(9) Contour**

After flat-drag engraving of the object finishes, the object's contours are engraved.

(10) Pitch

This sets the fill pitch (the spacing between adjacent tool paths).

Normally you should enter the diameter of the blade installed on the engraving machine. To ensure an attractive finish for flat-drag engraving, the pitch is generally set at a value smaller than the blade diameter.

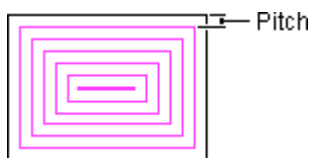
 **Related Topics**

[Changing the Measurement System for Numerical Values](#)

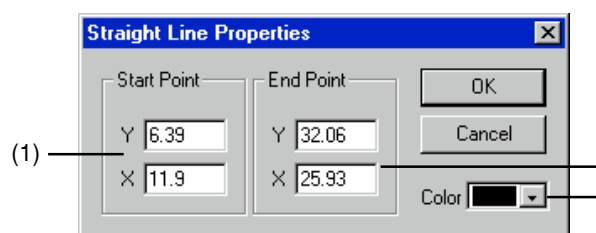
[Straight Line Properties] dialog box**(1) Start Point**

Enter the distance from the line's start point to the origin point. The start point is the drag starting point when plotting the line.

 Related Topics

[Changing the Measurement System for Numerical Values](#)

(2) End Point

Enter the distance from the line's end point to the origin point. The end point is the drag ending point when plotting the line.

 Related Topics

[Changing the Measurement System for Numerical Values](#)

(3) Color

Choose the line color.

 Related Topics

[Changing the engraving depth](#)

[Text Box Properties] dialog box

[Text Box] tab

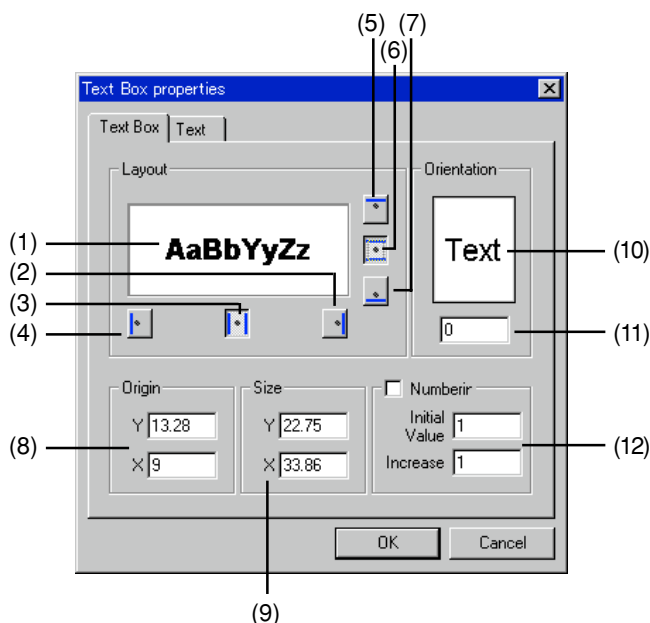

(1) This shows the layout of the text string in the text box.

(2) This lays out a right-aligned text string.



(3) This lays out a horizontally centered text string. When [Format] - [Direction] - [Horizontal] is selected, you can make the settings for justification and proportional spacing. Click the button to cycle through the sequence. When justification or proportional spacing has been selected, you cannot enter anything on the [Text] tab for [Width] or [Character Spacing].

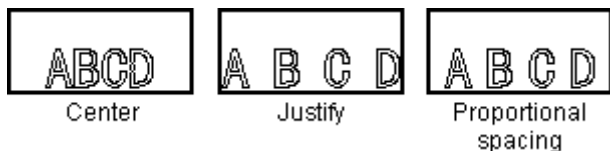

(4) This lays out a left-aligned text string.



(5) This lays out a top-aligned text string.



(6) This lays out a vertically centered text string. When [Format] - [Direction] - [Vertical] is selected, you can make the settings for justification and proportional spacing. Click the button to cycle through the sequence. When justification or proportional spacing has been selected, you cannot enter anything on the [Text] tab for [Height] or [Character Spacing].

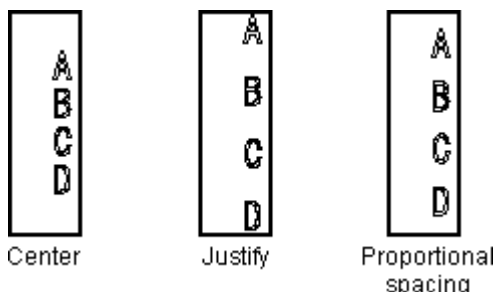

(7) This lays out a bottom-aligned text string.



(8) Origin Enter the distance from the lower-left point of the engraving area to the lower-left point of the text box.

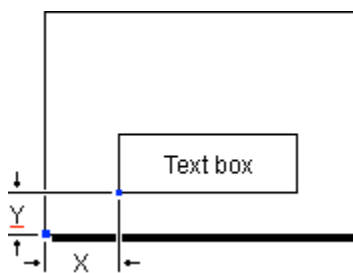

Related Topics

[Changing the Measurement System for Numerical Values](#)

(9) Size Enter the size of the text box.



(10) Drag to rotate the text box.

(11) Enter the angle of rotation for the text box. The units of measurement are degrees. Entering a positive value rotates the text box counterclockwise. Entering a negative value rotates it clockwise.

(12) Numberir

Numeric values are automatically entered in the text box. Enter the starting value in [Initial Value] and the value for incrementing it in [Increase]. You can also insert a zero in front of the number for [Initial Value].

As shown in the figure, numbering proceeds from the lower left to the upper right.



* When [Initial Value] = 1 and [Increase] = 1

[Text] tab

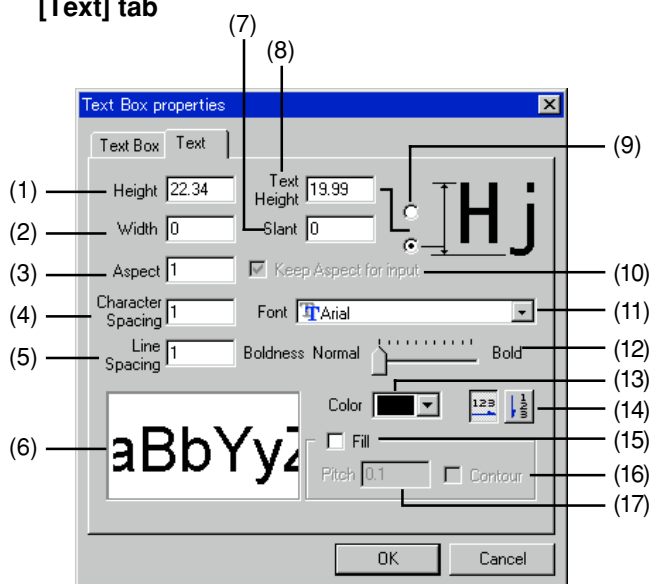

(1) Height

Enter the overall height for the text string. Changing this value also makes the [Text Height] value change accordingly.

Related Topics

[Changing the Measurement System for Numerical Values](#)

(2) Width

Enter the overall width for the text string.

Related Topics

[Changing the Measurement System for Numerical Values](#)

(3) Aspect

Enter the size as a ratio, with the vertical/horizontal aspect (vertical/horizontal ratio) when the text or shape was created as 1.

Entering a number changes the width without varying the height. Enter 2 to double the width. Enter 0.5 to halve it.

(4) Character Spacing

Enter the pitch (interval) for adjacent characters. Character size does not change.

Changing this value also makes the [Width] value change accordingly.

(5) Line Spacing

This specifies the spacing between adjacent lines.

(6)

This shows the shape of the text.

(7) Slant

Enter the degree of slant of the object.

The unit is in degrees.

Entering a positive angle makes the object slant to the right.

Entering a negative angle makes the object slant to the left.

(8) Text Height

Enter the height of the text.

The setting immediately affects all characters in the text string.

Changing this value also makes the [Height] value change accordingly.

Related Topics

[Changing the Measurement System for Numerical Values](#)

(9)

Choose the portion of the text for which you want to enter the height.

(10) Keep Aspect for input

This causes an object's aspect to be maintained at a fixed value when a numerical value is entered for Height or Width. When a value is entered for Height (or Width), the value of Width (or Height) changes automatically.

(11) Font

This displays the name of the selected font.

To change the font for the text, click on the down-pointing triangle.

(12) Boldness

Dragging the slider changes the thickness (weight) of text. A font cannot be made narrower than its standard weight. The left-hand end of the slider is standard weight, and the right-hand end is maximum weight.

(13) Color

Choose the line color of the text or shape.

When [Fill] is on, this changes to the fill color.

Related Topics

[Changing the engraving depth](#)

(14)

This setting determines whether the selected text is written vertically or horizontally.

(15) Fill

When on, the interior of the object (text or shape) is engraved by flat-drag cutting.

The route along which the tool moves (the tool path) is created along the contours of the object. Set the tool-path pitch with [Pitch].

The tool path is created on the inner side of the object. To engrave an object's contour lines, select [Contour].

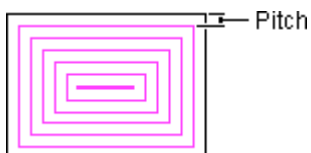

(16) Contour

After flat-drag engraving of the object finishes, the object's contours are engraved.

(17) Pitch

This sets the fill pitch (the spacing between adjacent tool paths).

Normally you should enter the diameter of the blade installed on the engraving machine. To ensure an attractive finish for flat-drag engraving, the pitch is generally set at a value smaller than the blade diameter.

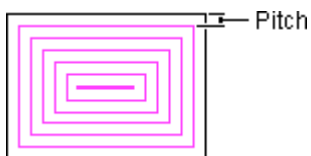

Related Topics

[Changing the Measurement System for Numerical Values](#)

[Template Properties] dialog box

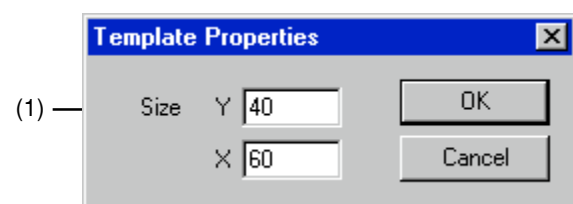

(1) Size

Enter the size of the template.

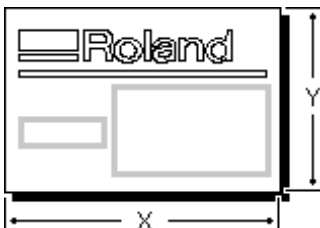

Related Topics

[Changing the Measurement System for Numerical Values](#)

[Shape] - [Fill] command

This performs flat-drag engraving of the interior of a graphic or text.

To engrave an object's contour lines, select [Contour]. When [Contour] is not selected, the contours of filled objects appear in gray.

Running this command displays the [Fill Setup] dialog box.

Specifying filling of combined polygons lets you perform flat-drag engraving between the inner and outer sides, as shown in the figure.



Related Topics

[\[Combine Polygons\] command](#)

[Fill Setup] dialog box

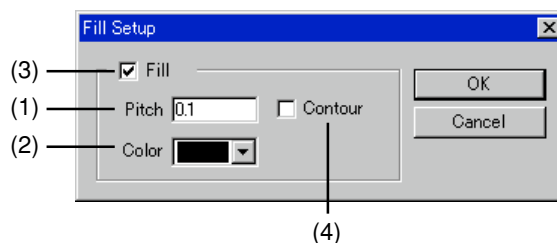

(1) Pitch

This sets the fill pitch (the spacing between adjacent tool paths).

Normally you should enter the diameter of the blade installed on the engraving machine. To ensure an attractive finish for flat-drag engraving, the pitch is generally set at a value smaller than the blade diameter.

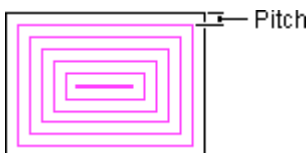

(2) Color

Choose the color of fill lines.

Related Topics

[Changing the engraving depth](#)

(3) Fill

When on, the interior of the object (text or shape) is engraved by flat-drag cutting.

The route along which the tool moves (the tool path) is created along the contours of the object. Set the tool-path pitch with [Pitch].

The tool path is created on the inner side of the object. To engrave an object's contour lines, select [Contour].

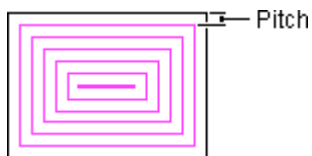

(4) Contour

After flat-drag engraving of the object finishes, the object's contours are engraved.

(2) X, Y

This specifies an object's position as a certain distance from the origin point.

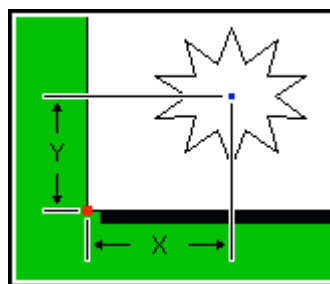

* When the object's center is taken to be the reference point

Related Topics

[Changing the Measurement System for Numerical Values](#)

[Shape] - [Move Shape...] command

This specifies an object's position as a certain distance from the origin point. Running this command displays the [Moving a Shape] dialog box.

[Moving a Shape] dialog box

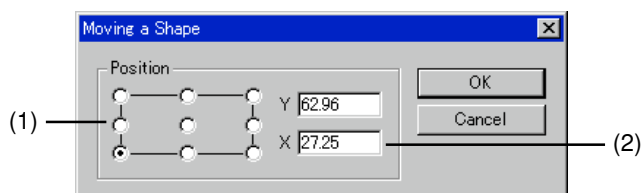

(1) Choose which portion of the object is to be used for specifying the position.

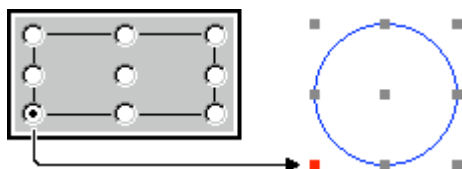

When more than one object is chosen, a rectangle enclosing all the objects is displayed.

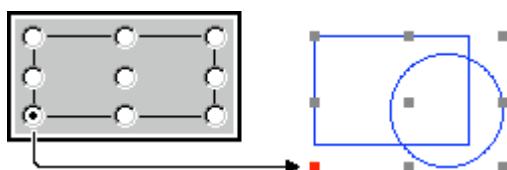

[Shape] - [Mirror] command

This flips an object from left to right, creating a mirror image.

[Shape] - [Convert to Polygon] command

This changes the attribute for an object other than a polygon to the attribute for a polygon.

Converting an object to a polygon with this command makes it possible for you to edit its points (vertices).

Once an object has been converted to a polygon, it cannot be returned to its original attribute (text, rectangle, rounded rectangle, circle/ellipse, or star).

[Shape] - [Combine Polygons] command

A number of objects can be grouped together and united into a single polygon.

They can then be moved or resized while maintaining the layout the objects had before they were joined together. The points of an object polygon that has been joined together in this fashion can be edited in the same way as an ordinary polygon.

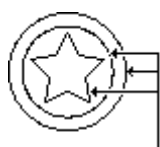

Can be treated as a single object

Specifying filling of combined polygons lets you perform flat-drag engraving between the inner and outer sides, as shown in the figure.



[Shape] - [Break Apart] command

A polygon can be split into individual parts.

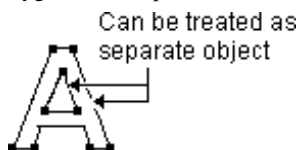

[Shape] - [Insert Vertex] command

This adds a vertex at the specified location.

 Keyboard shortcut: [Insert]

 Related Topics

[Adding a vertex to a polygon \(polyline\)](#)

[Shape] - [Delete Vertex] command

This deletes the selected vertex.

 Keyboard shortcut: [Delete]

 Related Topics

[Deleting a vertex of a polygon \(polyline\)](#)

[Shape] - [Connect Vertex] command

This connects the endpoints of an open polygon (polyline) with a line.

To connect vertices, choose two open endpoints of a polygon (polyline), then run this command.

Connecting to the endpoint of a different polygon (polyline)

1. Select the target polygon.
2. At the [Shape] menu, click [Combine Polygons].
3. Select the two endpoints.
4. At the [Shape] menu, click [Connect Vertex].

 Keyboard shortcut: [Alt]+[Insert]

[Shape] - [Server Vertex] command

This severs a polygon (polyline) at a specified location.

To specify the severance point, click on one of the polygon's line segments or vertices.

 Keyboard shortcut: [Alt]+[Delete]

[Shape] - [Snap to Vertex] command

This overlays the selected vertex on the closest vertex.

Snapping to the vertex of a different polygon (polyline)

1. Select the target polygon.
2. At the [Shape] menu, click [Combine Polygons].
3. Select the vertex to snap to.
4. At the [Shape] menu, click [Snap to Vertex].

[Shape] - [Symbols] command

This adds a symbol to the file being edited.
Running this command opens the [Symbol] dialog box.

[Symbol] dialog box

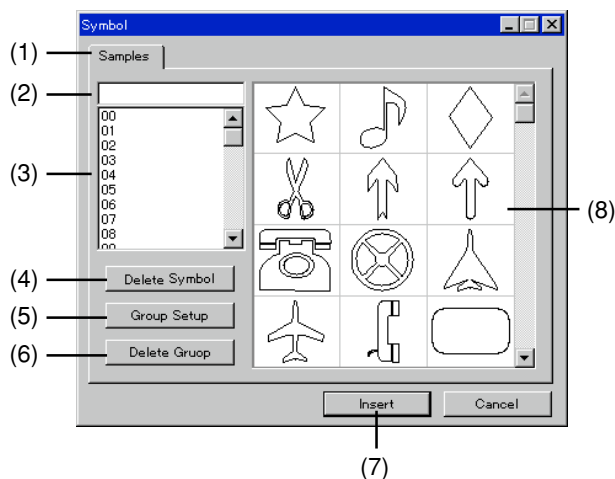

- (1) The symbol and group names appear. Click the tab and select the group.
- (2) The name of the selected symbol is displayed. Entering a symbol name selects the specified symbol.
- (3) A list of symbol names is displayed. Click on the name of a symbol to select it.
- (4) This deletes the selected symbol.
- (5) This changes the name of the currently selected group. The [Change Group Name] dialog box appears. Enter the name of the group in the dialog box.
- (6) This deletes the currently selected group. Any symbols registered in the group are all deleted as well.
- (7) This adds the selected symbol to the file being edited.
- (8) A list of symbol shapes is displayed. Click on a symbol to select it.

[Shape] - [Add Symbol] command

It is used to register a symbol with a Dr. Engrave object.
Running this command opens the [Add Symbol] dialog box.

[Add Symbol] dialog box

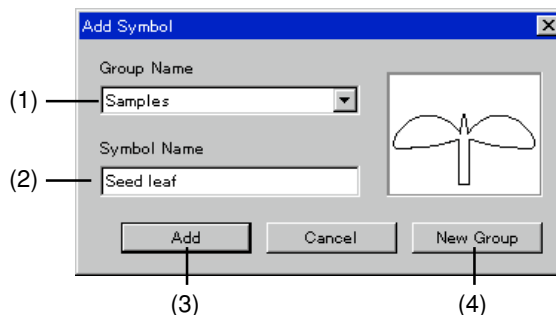

- (1) Select the group where the symbol is to be registered. Click to display a list of existing group names. To add a new group, click [New Group].
- (2) Enter the symbol name for the selected object.
- (3) The selected object is registered as a symbol.
- (4) This adds a new group for the symbol. The [New Group] dialog box appears. Enter the name of the group in the dialog box.

Commands - [Layout] menu

[Layout] - [Layout Setup] command

This lays out multiple templates within the area.

If you want to lay out a template file that's being edited, save the file before you run this command. After you change to the Plate Layout mode, you can't save the template file.

Running this command displays the [Layout Setup] dialog box.

[Layout Setup] dialog box

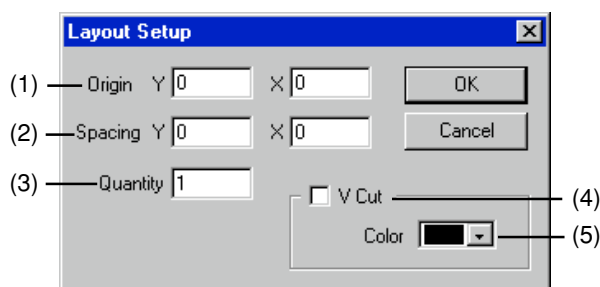

(1) Origin

Enter the position of the lower-left point of the plate laid out at the lower left within the page.

Enter the distance from Dr. Engrave's origin point.

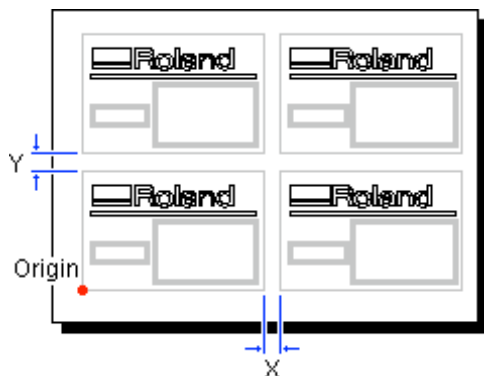

Related Topics

[Changing the Measurement System for Numerical Values](#)

(2) Spacing

Set the spacing between adjacent plates.

Related Topics

[Changing the Measurement System for Numerical Values](#)

(3) Quantity

Enter the number of laid-out templates.

(4) V Cut

Enter the cutting-in amount for the plate outline.

You can engrave a number of plates on a single plate, and after engraving, separate the plates along the V-cut lines.

The plate size after engraving is reduced by an amount equal to the V-cut width. To obtain the desired finished plate size, specify a plate size with the V-cut width already added to it. The V-cut width may differ according to the blade configuration and cutting-in depth.

To set the V-cut cutting-in depth, set the color of the line.

When on, the plate spacing is set at 0 (zero).

Related Topics

[Dividing a single plate to create multiple plates](#)

[Changing the engraving depth](#)

(5) Color

Choose the color of the V-cut line.

The color shows the cutting-in depth. The depths of the various colors can be set with the driver for the engraving machine. For more information about how to make the settings, see the help screens for the driver.

Related Topics

[Changing the engraving depth](#)

[Layout] - [Edit Template] command

This changes the contents of an imported template.

Running this command calls up the Template Edit screen.

Changes in the values immediately affect the laid out plates. Note that the referenced template file does not change.

To go back to the Plate Layout screen, run the [Return to Layout] command.

[Layout] - [Return to Layout] command

When editing a template with the [Edit Template] command, this returns you to the Plate Layout screen.

[Layout] - [Move To Front] command

This changes the front-back relationship of the objects.

The selected object is moved to the front.

Keyboard shortcut: [Shift]+[Page Up]

[Layout] - [Move To Back] command

This changes the front-back relationship of the objects. The selected object is moved to the back.

 Keyboard shortcut: [Shift]+[Page Down]

[Layout] - [Align] command

All selected objects are aligned at their centers. If you have selected a number of objects while holding down the [Shift] key, the objects are overlaid atop the last object you chose. If you've selected a number of objects by dragging an area, the objects are overlaid atop the object in the foreground.

Related Topics

[Aligning the centers of a number of objects](#)

Commands - [Help] menu

[Help] - [Contents] command

This displays the contents page for online help.

[Help] - [About Dr.Engrave...] command

This displays the version number and copyright information for Dr. Engrave.

5



**If You Think
There's a Problem**

If You Think There's a Problem

Dr. Engrave doesn't function

Does the computer you're using provide the correct operating environment for Dr. Engrave?

Check the conditions for the Dr. Engrave operating environment and make sure that the computer offers a suitable environment.

Was the software installed using the setup program?

The setup program puts the files for Dr. Engrave in the necessary locations to enable the software to be used under Windows.

Engraving machine doesn't function

Was the correct port selected for the printer driver?

The data-output port is set with the printer driver. Open the driver's properties, and on the [Details] tab, check the setting for [Print to the following port:].

Is the cable connected?

Switch off the power to the computer and the output device, and use an interface cable to connect the two devices.

Is the correct type of cable used?

The type of interface cable may vary according to the computer model. Make the connection with the correct type of cable for the computer.

Be sure the computer and the output device are both switched off before attempting to attach or disconnect the interface cable.

Error Messages

XXXXX Illegal Font Select.

The Dr. Engrave file you tried to open contains fonts that are not registered in Windows. When this happens, a list of substitute fonts is displayed.

The file may have been made on a machine with a different font environment, or some fonts may have been deleted from Windows. To reproduce the original image, make sure the necessary fonts are installed.

Not enough memory.

If insufficient memory occurs during processing, close all other applications or restart Windows.

If the message about insufficient memory still appears, check the amount of free space on your hard disk. Windows normally uses a portion of the hard disk for virtual memory, and it may be that there is not enough space left on the hard disk. If this is the case, free up space on the hard disk by deleting unneeded files or moving them to another disk. If the message about insufficient memory still appears after doing this, it is recommended that you increase the amount of memory in your computer.

Could not generate outline.

An outline could not be extracted because of the faint color of data imported using a scanner or Windows bitmap data imported with the [Import] command. Adjust the data to a darkness that allows an outline to be extracted and import the data again.

Related Topics

[Using a scanner to import an object](#)
[Importing bitmap data](#)

Unexpected file format.

A file opened with the [Open] command, imported with the [Import] command or imported with the [Import Text] is in a format that Dr. Engrave does not recognize. Use a file format that Dr. Engrave can recognize.

File formats that can be imported

Windows Bitmap:

Extension *.bmp ([Import] command only)

CSV:

Extension *.csv ([Import Text] command only)

Text:

Extension *.txt ([Import Text] command only)

Document file of Dr.Engrave:

Extension *.ded ([Open] command only)

Template file of Dr.Engrave:

Extension *.det ([Open] command only)

Base font XXXXX not found. Choose substitute font or click Cancel and install selected font.

The stroke font file you're trying to open has a setting for a base font that's not registered with Windows. The file may have been created on a machine with a different font environment, or the font may have been deleted from Windows.

Click [Finish] and install the font in Windows, or click [Substitute] change the setting for the base font.

Clicking [Substitute] allows existing stroke characters to remain without being regenerated. Note that after a font has been substituted, the substitute font is used as the base design for creating stroke characters.

Other symptoms

The stroke characters are not evenly aligned in a horizontal row.

When horizontal stroke characters are entered, the characters may not be evenly aligned in a horizontal row.



This happens because the spacing between the base line and the text differs from one character to another. When text is written horizontally, the base lines of adjacent characters are lined up along a horizontal line so that there is no unevenness. Because the character centerlines are extracted and converted to stroke characters, the spacing between the base line and the character may become ragged, as shown in the figure.



If this happens, correct the shape of the characters so that the spacing between the base line and the character becomes uniform.

The stroke characters are not converted correctly.

When text is been converted to stroke characters, some text may not be converted correctly.

Here are some of the main reasons why this may happen.

- The width of the lines forming the characters is uneven.

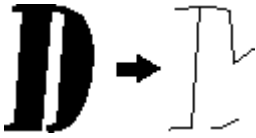

- The characters are too wide, and the direction of line extension cannot easily be determined.



- Serifs, balls, and other flourishes may deform the lines.

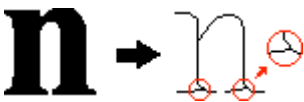

In such cases, use the [Format] - [Edit Stroke...] command to correct the shape of the stroke characters.



Appendixes

Operating Procedures of SFEdit

1 Names and functions

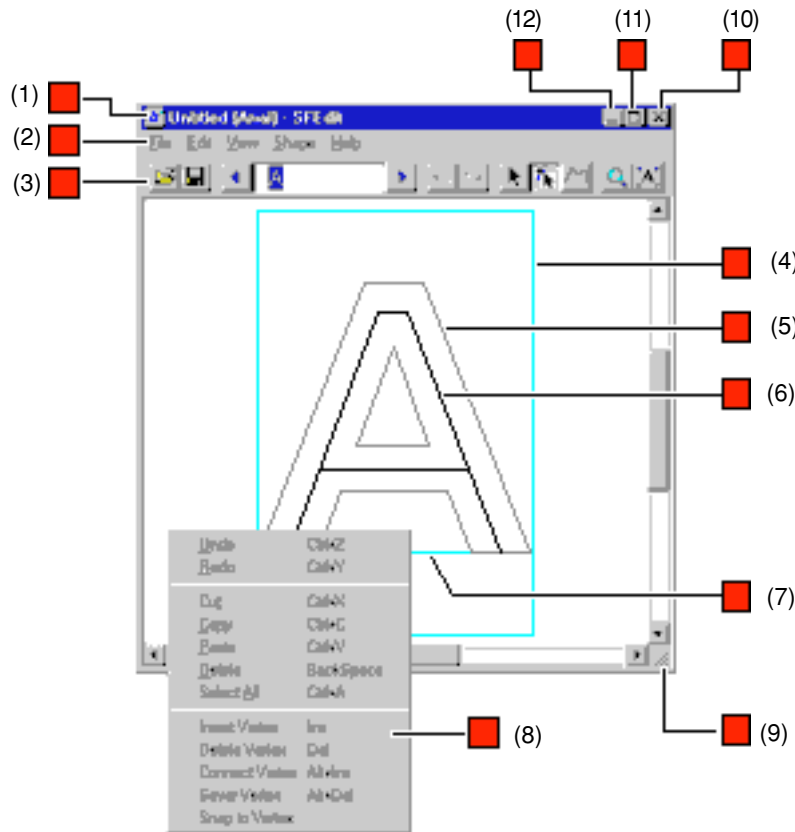

(1) Title bar

The file name, base font name and program name are displayed here.

The window can be moved by dragging the title bar.

(2) Menu Bar

Runs the various commands for SFEdit.

(3) Toolbar

The toolbar is provided with buttons for running SFEdit commands such as [Open...] and [Save]. Moving the mouse pointer over a button displays a brief description of the button's function.

(4)

The size of the box differs according to the type of base font and the character. Normally you should create the text so that it fits inside the box.

(5) Base font text

This is displayed as a rough draft for editing stroke characters. A base font serves as the design base for a stroke font.

If you don't want to display base font text, set [View] - [Base Font] to "off."

(6) Stroke characters

All stroke characters are made up of polylines and lines. You can edit them by adding or deleting vertices, adding line segments, and so on.

(7) Base line

This is the reference line for lining up a text string horizontally. When text is written horizontally, the base lines of adjacent characters are lined up along a horizontal line so that there is no unevenness.

(8) Popup menu

Clicking the right mouse button within an editing area makes a menu appear.

You can use this menu to run the following commands.

(9)

When the mouse pointer is moved close to here, the pointer changes to a diagonal arrow. You can then change the window size by dragging.

(10) Close button

This ends the program.

If changes made to the file being edited have not been saved, a dialog box asking if you wish to save the changes is displayed.

(11) Maximize button

This expands the window to fill the screen.

(12) Minimize button

This shrinks the window to a button on the taskbar.



2 Operation Procedures

Step1: Choose the text

Choose the character whose shape you want to touch up. The character you chose appears on the SFEdit editing screen, where you can reposition vertices, add line segments, and do other things as well.

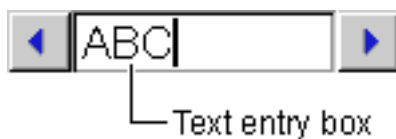
1. Click on the toolbar's text-entry box, then enter the text string. If a text string has already been entered, go to 2 below.





2. Click the  or  button. The presently selected character is displayed in reverse video. Use these buttons to move the reversed portion and select the desired character.



Step2: Correct the shape of the character

Use SFEdit's editing features to correct the shape of the character. This section describes how to move a vertex, add a vertex, and delete a vertex. For other editing functions, see the [explanation for the particular command](#).

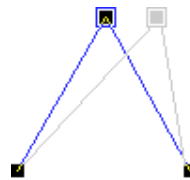

Moving a vertex

1. Click the  button.
2. Click on a polyline (or straight line).
3. Drag the vertex ().



- * To select a number of vertices, hold down the [Shift] key while clicking on each vertex (). Alternatively, drag an area that includes the vertices you want to select. To move the vertices, drag any one of the selected vertices ().

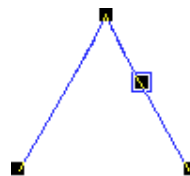

Adding a vertex

1. Click the  button.
2. Click on a polyline (or straight line).
3. Position the pointer over a line, and click. The location for adding the vertex () appears.



4. From the [Shape] menu, click [Insert Vertex]. You can also double-click on a line in a graphic and add a vertex.

Deleting a vertex

1. Click the  button.
2. Click on a polyline (or straight line).
3. Click on the vertex.
The selected vertex changes to a square with a border ().
To delete two or more vertices at the same time, hold down the [Shift] key as you click on each vertex (). Alternatively, drag the mouse over the vertices to be deleted.
4. From the [Shape] menu, click [Delete Vertex].

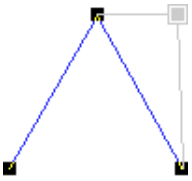

Related Topics

[Basic Operations](#)



Step3: Save the file

Save the corrected character to a file.
Saving the file causes the results of the change to immediately affect the text string referencing this file.

1. Click the  button.
The [Save As] dialog box appears. If you're editing an existing file, no dialog box appears.
2. Enter the name of the file and click [Save].

3 Basic Operations

Selecting a vertex

1. Click the  button.
2. Click on a polyline (or straight line).
3. Click on the vertex.
The selected vertex changes to a square with a border ().

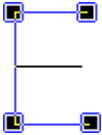



When a vertex is chosen, pressing the [Tab] key selects a different vertex. To invert the vertex selection order, hold down the [Shift] key and press [Tab].



Canceling the selection of a vertex

1. Click the  button.
2. Click on an area other than the selected vertex.

Moving a vertex horizontally or vertically

1. Click the  button.
2. Click on a polyline (or straight line).
3. While holding down the [Shift] key, drag the vertex () up, down, or to the left or right.

Selecting multiple vertices

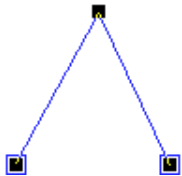

1. Click the  button.
2. Click on a polyline (or straight line).
3. Hold down the [Shift] key and click on each vertex ().
Alternatively, drag the mouse over the vertices to be selected.



Each selected vertex changes to a square with a border (). To select all the vertices included in a polyline (or straight-line) shape, hold down the [Ctrl] key as you click on the vertex.



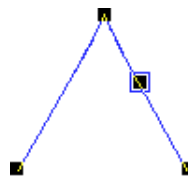

Adding a vertex

1. Click the  button.
2. Click on a polyline (or straight line).
3. Position the pointer over a line, and click.
The location for adding the vertex () appears.
4. From the [Shape] menu, click [Insert Vertex].





You can also double-click on a line in a graphic and add a vertex.

Deleting a vertex

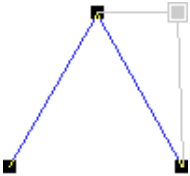
1. Click the  button.
2. Click on a polyline (or straight line).
3. Click on the vertex.
The selected vertex changes to a square with a border ().
To delete two or more vertices at the same time, hold down the [Shift] key as you click on each vertex (). Alternatively, drag the mouse over the vertices to be deleted.
4. From the [Shape] menu, click [Delete Vertex].



Selecting a polyline (or straight line)

1. Click the  button.
2. Move the mouse cursor to the polyline (or straight line) object to be selected, and click the mouse.
3. The symbols  and  appear around the selected polyline (or straight line).

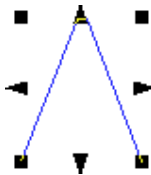

When a polyline (or straight line) is chosen, pressing the [Ctrl] and [Tab] key selects a different polyline (or straight line). To invert the polyline (or straight line) selection order, hold down the [Shift] and [Ctrl] key then press [Tab].

Selecting multiple polylines (or straight lines)

1. Click the  button.
2. While holding down the [Shift] key, click on each of the polylines (or straight lines) you wish to select.
Alternatively, drag the mouse over the polylines (or straight lines) to be selected.

Canceling the selection of a polyline (or straight line)

1. Click the  button.
2. Click on an area other than the selected polyline (or straight line).

Moving an polyline (or straight line) horizontally or vertically

1. Click the  button.
2. Click on the polyline (or straight line) to select it.
3. While holding down the [Shift] key, drag the polyline (or straight line) up, down, or to the left or right.

Making an polyline larger or smaller

1. Click the  button.
2. Click on the polyline to select it.
3. Change the size of the polyline (or straight line) by dragging the points (■ and ▲) that appear around the object.

The size can be freely changed by dragging a square point (■).

The size can be changed while maintaining the shape's vertical and horizontal aspect by holding down the [Shift] key while dragging.

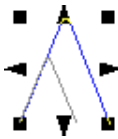

The triangular points (▲) on the left and right can be dragged to change the horizontal size.

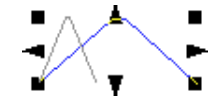

The triangular points (▲) above and below can be dragged to change the vertical size.



Drawing a polyline (or straight line)

1. Click the  button.
2. Click on the vertices and draw the polyline (or straight-line) shape.
3. To end creation of a polyline shape, double-click on the end point.
To create straight line, double-click on the second vertex.

4 Commands

Toolbar buttons

The toolbar is provided with buttons for running SFEdit commands such as [Open...] and [Save]. Moving the mouse pointer over a button displays a brief description of the button's function.

The buttons provided on the toolbar are as shown below. Click on a button's icon to display an explanation of the command.



This opens a SFEdit file. Running this command opens the [Open] dialog box.



This saves the file, overwriting the previous version of the file.

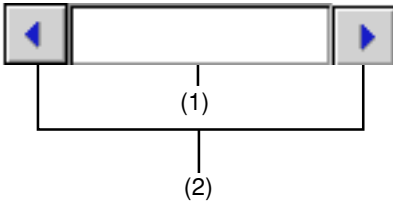

(1) Text entry box

Enter the text you want to edit. Select a character by clicking the left or right arrow button or double-clicking on the character. To edit or browse line characters that have already been registered, then at the [Shape] menu, click [Character List].

(2) Arrow buttons

These choose the character you want to edit from the text string in the text entry box. The character in the text entry box that is displayed in reverse video is the presently selected character. Use these buttons to move the reversed portion and select the desired character.



This selects a polyline (or straight line). To select a polyline (or straight line), move the mouse pointer over the polyline (or straight line) and click. When a polyline (or straight line) is chosen, pressing the [Ctrl] and [Tab] key selects a different polyline (or straight line). To invert the polyline (or straight line) selection order, hold down the [Shift] and [Ctrl] key then press [Tab].



This cancels an [Undo] command that has just been run.



This cancels an [Redo] command that has just been run.



This shifts the position of a vertex and changes the shape of a polyline (or straight line). Clicking this button then clicking overtop the polyline (or straight line) display's the vertices (■). Double-click on a line to add a vertex. Drag one of the square pointers (■) to change the position of the corresponding vertex. Dragging a vertex to a point near a line or another vertex makes it snap to the line or vertex. To keep it from snapping, hold down the [Ctrl] key while dragging. Making the endpoints of a polyline snap together produces a closed polygon. When a vertex is chosen, pressing the [Tab] key selects a different vertex. To invert the vertex selection order, hold down the [Shift] key and press [Tab].



This creates a polyline (or straight line) by clicking on vertices. To end creation, double-click on the end point. Right-click or press [Esc] while creation is in progress to delete a vertex. To create a line, double-click on the second vertex (end point). Clicking this button changes the mouse pointer to the shape-drawing tool (+).



This enlarges or reduces the view of the object. Clicking the left mouse button show an enlarged view with the point where clicked at the center. The area to be enlarged can also be specified by dragging with the mouse. Clicking the right mouse button shows a reduced-size view.



This command expands or reduces the size of the object shown to fill the screen.

Commands - [File] menu

[File] - [New] command

This creates new stroke fonts.

A dialog box is displayed for selecting the font to serve as the design base for the stroke font (the base font).

If changes made to a file being edited have not been saved, a dialog box asking if you wish to save the changes is displayed.

▶ Keyboard shortcut: [Ctrl]+[N]

[Select Base Font] dialog box

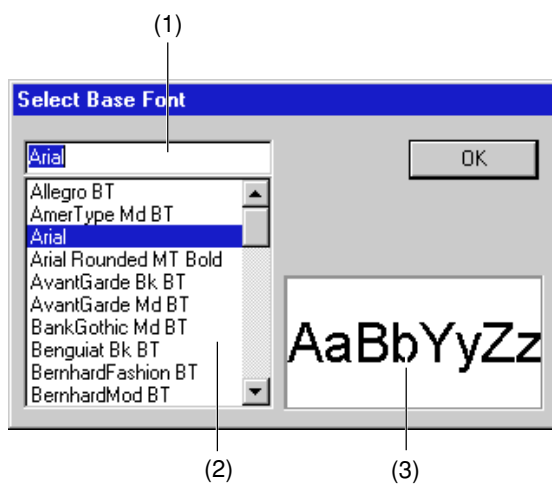

- (1)
This displays the selected font.
To choose a font, click the font name in the list or enter the font name.
- (2)
This displays the fonts available for selection. Click on a font in the list to choose it.
Only **TrueType fonts** registered in Windows are displayed.
- (3)
This displays the form of the selected font.



[File] - [Open...] command

This opens a SFEdit file.

Running this command opens the [Open] dialog box.

If changes made to a file being edited have not been saved, a dialog box asking if you wish to save the changes is displayed.

▶ Keyboard shortcut: [Ctrl]+[O]

[Open] dialog box

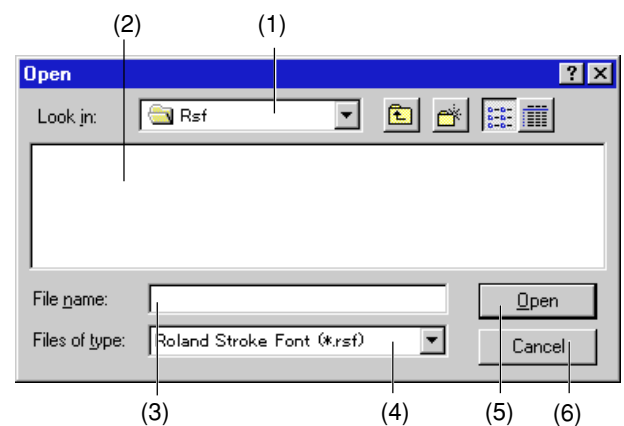

- (1)
Choose the area where the file has been saved.
- (2)
The folders and files in the [Look in] are displayed.
Double-click on a file to open it. Double-click on a folder to open it and see the files inside.
- (3)
Enter the file name.
- (4)
Select the type of file.
Only files with the chosen extension are listed. To list all files, choose "All Files (*.*)"."
- (5) [Open] button
If a file in the file list has been selected, click this button to open the file.
If a folder has been selected, click this button to open the folder and view its contents.
- (6) [Cancel] button
This closes the dialog box.



[File] - [Save] command

This saves the file, overwriting the previous version of the file. To save the file with a different name or in a different area, use the [Save As...] command.

▶ Keyboard shortcut: [Ctrl]+[S]

[File] - [Save As...] command

This saves the file with a different name. Running this command opens the [Save As] dialog box. Windows 95 long file names are supported. Normally, ".rsf" is used as the file extension.

[Save As] dialog box

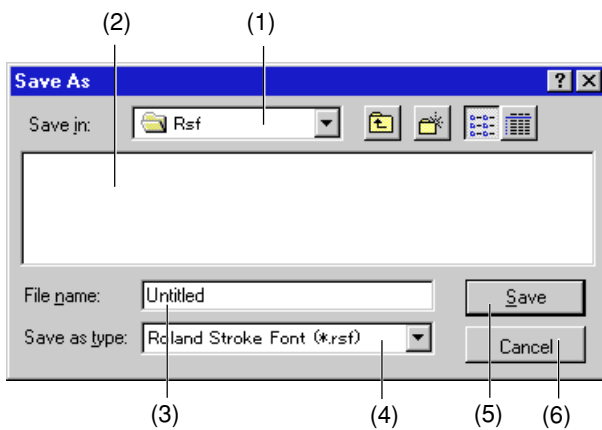

- (1) Choose the area where the file is to be saved. To enable selection of the created stroke font with Dr. Engrave, save the file in the [Rsf] folder.
- (2) The folders and files in the [Save in] are displayed. Double-click on a folder to open it and see the files inside.
- (3) Enter the name for saving the file. The extension selected for [Save as type] is appended to the file name.
- (4) Select the extension for the file to be saved. The file extension helps Windows determine the application associated with the file. **SFEdit files** use ".rsf" as their extension. Normally, this should be set to "Roland Stroke Font (*.rsf)."
- (5) [Save] button
This saves the file to the selected [Save in].
- (6) [Cancel] button
This closes the dialog box.

[File] - [Exit] command

This ends the program. If changes made to the file being edited have not been saved, a dialog box asking if you wish to save the changes is displayed.

▶ Shortcut:



Click the button for closing the application window.

Commands - [Edit] menu

[Edit] - [Undo] command

This erases the change just made and returns to the previous form.

▶ Keyboard shortcut: [Ctrl]+[Z]

[Edit] - [Redo] command

This cancels an [Undo] command that has just been run.

▶ Keyboard shortcut: [Ctrl]+[Y]

[Edit] - [Cut] command

This deletes the selected object, and copies it to the clipboard. The contents of the clipboard are maintained until another object is copied to the clipboard. To paste the clipboard contents, run the [Edit] - [Paste] command.

▶ Keyboard shortcut: [Ctrl]+[X]

[Edit] - [Copy] command

This copies the selected object to the clipboard. The contents of the clipboard are maintained until another object is copied to the clipboard. To paste the clipboard contents, run the [Edit] - [Paste] command.

▶ Keyboard shortcut: [Ctrl]+[C]

[Edit] - [Paste] command

This copies the contents of the clipboard, pasting them at the selected on-screen location. You can only paste SFEdit polylines (or straight lines). Shapes created with another program cannot be pasted via the clipboard.

▶ Keyboard shortcut: [Ctrl]+[V]

[Edit] - [Delete] command

This deletes the selected object. The deleted object is not copied to the clipboard.

▶ Keyboard shortcut: [Delete]

[Edit] - [Select All] command

This selects all objects displayed on screen.

▶ Keyboard shortcut: [Ctrl]+[A]

Commands - [View] menu



[View] - [Zoom In] command

This displays an enlarged view of the object.

Keyboard shortcut: [Ctrl]+[Page Down]



[View] - [Zoom Out] command

This displays an reduced view of the object.

Keyboard shortcut: [Ctrl]+[Page Up]

[View] - [Toolbar] command

This toggles the display of the toolbar on or off. The toolbar is provided with buttons for running SFEdit commands such as [Open...] and [Save]. Moving the mouse pointer over a button displays the button's name. Toggling off the display of the toolbar enlarges the area of the edit screen.

Related Topics

[Toolbar buttons](#)

[View] - [Base Font] command

This toggles the display of the base font on or off.

[View] - [Grid] command

This toggles the display of the grid on or off. The default for grid spacing is 50, both horizontally and vertically. These values do not correspond to any measurement unit. The grid may sometimes not be displayed, depending on the screen's zoom factor or the grid spacing.

[View] - [Snap To Grid] command

When this is on, polyline and its vertices are automatically aligned with the grid lines. Alignment with the grid lines can make it easier to arrange the position of polyline and vertices. When SFEdit has just been installed, this function is off.

[View] - [Grid Setup...] command

This makes the settings for grid interval, whether the grid is displayed, and whether the snap to grid function is on or off. Running this command displays the [Grid Setup] dialog box.

[Grid Setup] dialog box

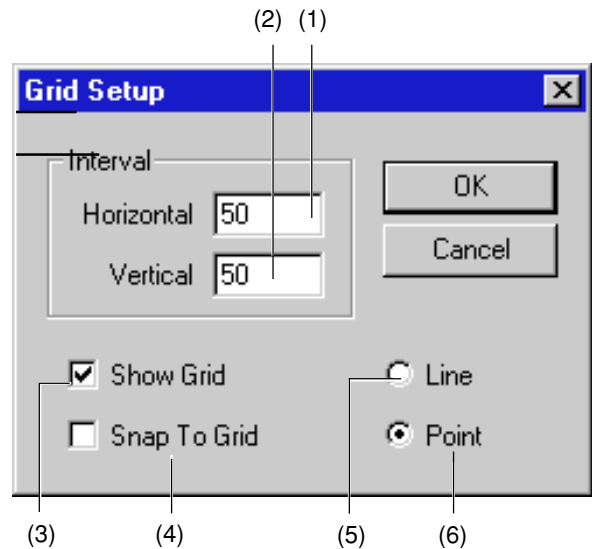

(1)

Enter the interval for horizontally adjacent grid lines. The default value is 50. This value does not correspond to any measurement unit.

Setting range: 0—1000

(2)

Enter the interval for vertically adjacent grid lines. The default value is 50. This value does not correspond to any measurement unit.

Setting range: 0—1000

(3)

This toggles the display of the grid on or off.

(4)

This toggles the function for snapping objects to the grid on or off.

(5)

The grid is shown with dotted lines.

(6)

The grid is shown with unbroken lines.



[View] - [Fit to Screen] command

This command expands or reduces the size of the object shown to fill the screen.

Commands - [Shape] menu

[Shape] - [Character List...] command

This displays a list of characters which have been converted to stroke characters.

Running this command displays the [Stroke Font Table] dialog box.

[Stroke Font Table] dialog box

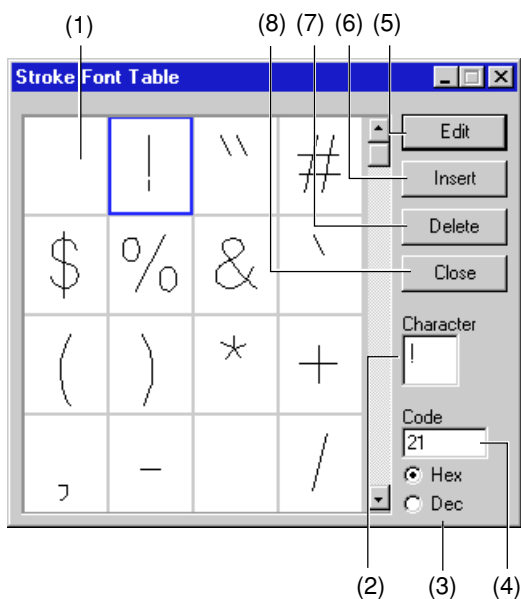

(1)
A list of characters converted to stroke characters appears.
Double-click to make the character appear on the edit screen.

(2) Character
This displays a character selected from the list of characters.
You can also enter a character and display a registered character.

(3) Code
This displays the character code (ASCII) of a character selected from the list of characters.
You can also enter a character code and display a registered character.

(4)
Select the number system of the character code.
You can select this item when the base font is 1-byte character font.

(5) [Edit] button
This makes the character selected from the list of characters appear on the edit screen.

(6) [Insert] button
This adds a character (graphic) chosen from the list of characters to the text now being edited.

(7) [Delete] button
This deletes a selected character from the list of characters.

(8)
Select the number system of the character code.
You can select this item when the base font is 1-byte character font.

[Shape] - [Regenerate Stroke Character] command

This regenerates the stroke character being edited and displays it on screen.

The stroke character being edited is cleared away and replaced with a regenerated stroke character.

This is used to redo editing of the character in question from the very beginning.

[Shape] - [Stroke Character Batch Generate...] command

This converts all base-font text to stroke characters.
Running this command displays the [Make Stroke All] dialog box.

[Make Stroke All] dialog box

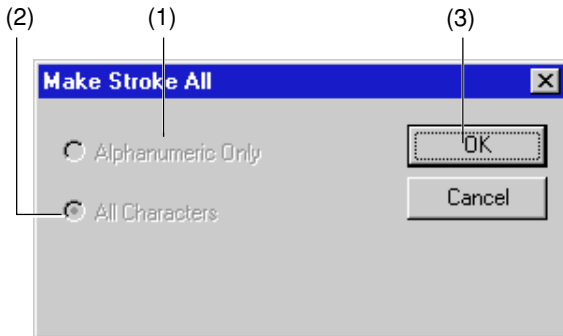

(1) Alphanumeric Only

This converts the alphanumerical text of base font to stroke characters, but don't generates the stroke characters that have already been converted.

You can select this item when the base font is 2-byte character font.

(2) All Characters

This converts all base-font text to stroke characters, but don't generates the stroke characters that have already been converted.

You can select this item when the base font is 2-byte character font.

(3)

This starts to generate the stroke characters.

[Shape] - [Insert Vertex] command

This adds a vertex at the specified location.

 Keyboard shortcut: [Insert]

Related Topics

[Adding a vertex](#)

[Shape] - [Delete Vertex] command

This deletes the selected vertex.

 Keyboard shortcut: [Delete]

Related Topics

[Deleting a vertex](#)

[Shape] - [Connect Vertex] command

This connects two selected vertices with a line.

Choose two vertices at the ends of a polyline (or straight line).

You can't run this command if only one vertex is chosen or if one or the other of the two vertices isn't an end of a polyline (or straight line).

 Keyboard shortcut: [Alt]+[Insert]

[Shape] - [Sever Vertex] command

This severs a polyline (or straight line) at a specified location.

To specify the severance point, click on the line or vertex.

 Keyboard shortcut: [Alt]+[Delete]

[Shape] - [Snap to Vertex] command

This overlays the selected vertex on the closest vertex.

To snap to the vertex of another
polyline (or straight line)

1. Click the  button
2. While holding down the [Shift] key, click the polyline (or straight line) that contains the vertex you want to snap to, and click the polyline (or straight line) you want to snap to.
3. Select the vertex to snap to.
4. From the [Shape] menu, click [Snap to Vertex].

Commands - [Help] menu

[Help] - [Contents] command

This displays the contents page for online help.

[Help] - [About SFEdit...] command

This displays the version number and copyright information for SFEdit.

5 Error Messages

Base font XXXXX not found. Choose substitute font or click Cancel and install selected font.

The line-character font file you're trying to open has a setting for a base font that's not registered with Windows. The file may have been created on a machine with a different font environment, or the font may have been deleted from Windows. Click [Finish] and install the font in Windows, or click [Substitute] change the setting for the base font. Clicking [Substitute] allows existing line characters to remain without being regenerated. Note that after a font has been substituted, the substitute font is used as the base design for creating line characters.

Not enough memory

If insufficient memory occurs during processing, close all other applications or restart Windows. If the message about insufficient memory still appears, check the amount of free space on your hard disk. Windows normally uses a portion of the hard disk for virtual memory, and it may be that there is not enough space left on the hard disk. If this is the case, free up space on the hard disk by deleting unneeded files or moving them to another disk. If the message about insufficient memory still appears after doing this, it is recommended that you increase the amount of memory in your computer.

File input/output failed.

An error occurs when opening or saving a file. If the error appears when saving a file The disk you want to save the file to is write-protected, or the file you're trying to overwrite is read-only. Save the file on a disk that isn't write-protected, or change the file attributes to enable it to be written to. If the error appears when opening a file The file you're attempting to open is not in SFEdit file format. Open an SFEdit file.

Glossary

Object

This is the collective name for shapes and blocks of text.

Dr.Engrave file

This is a file saved in Dr. Engrave format.

Windows BMP (bitmap)

BMP (Windows bitmap) is a standard graphical file format for Windows. It can be used to store bitmap data. All graphics are represented as a collection of dots.

SFEdit file

This is a file saved in SFEdit format. Normally, ".rsf" is used as the file extension.

TrueType font

This is one type of outline font system that represents text as an outline and a filled portion. It is provided as standard on Windows.

Vector data

Vector data is a data format that represents images (text and shapes) as a set of reference points and the lines that connect them. Most draw-type software applications can be used to create vector-data images.

Bitmap data

Bitmap data is a data format that represents images (text and shapes) as a collection of dots. Most paint-type software applications show images as bitmaps.

Resolution

This is a scale that indicates the precision of images displayed on screen, printed on the printer, or acquired with the scanner. The larger the number, the more detailed and attractive is the image it represents.

Gradations

This indicates the smoothness of changes in color when colors are used.

Indicate

This indicates the smoothness of changes in color when colors are used.

Clipboard

The clipboard is used to hold data temporarily when it is being copied or cut. The clipboard is a standard feature of Windows.

CSV

This is one format for saving data from a database, spreadsheet, or the like as a text file. Text (or numerals) entered into fields or cells are exported to a file in comma-separated format. In addition to the CSV format, which uses commas as separators, some programs let you specify tabs or spaces as separators.

Index

- A**
- [About Dr.Engrave...] command 53
 - [About SFEdit...] command 72
 - [Acquire...] command 35
 - [Add Symbol] command 51
 - [Add Symbol] dialog box 51
 - Align 27, 28
 - [Align] command 53
 - Arrow button 65
 - Aspect 26, 42, 44, 47
- B**
- [Base Font] command 69
 - Base font text 59
 - "Base font XXXXX not found." 56
 - Base line 56, 59
 - Bitmap data 28, 31, 74
 - BMP (bitmap) 74
 - BMP file 31
 - [Break Apart] command 50
- C**
- Cancel 12
 - Changing the engraving depth 18
 - Changing the measurement system 29
 - Changing the point snaps 28
 - [Character List...] command 70
 - [Character Spacing] command 40
 - Clipboard 28, 37, 74
 - Close button 7, 59
 - Code 70
 - [Combine Polygons] command 49
 - [Connect Vertex] command 50
 - [Contents] command 53, 72
 - [Convert to Polygon] command 49
 - [Copy] command 37, 68
 - "Could not generate outline." 55
 - Creating circles 26
 - Creating regular polygons 27
 - Creating squares 26
 - CSV 74
 - [Custom...] command 38
 - [Cut] command 37, 68
 - Cutting-in amount 21, 24
- D**
- Default settings 36
 - [Delete] command 37, 68
 - [Delete Vertex] command 50
 - Dialog box
 - [Add Symbol] 51
 - [Fill Setup] 48
 - [Font Select] 40
 - [Grid Setup] 39, 69
 - [Layout Setup] 20, 23, 52
 - [Make Stroke All] 71
 - [Moving a Shape] 49
 - [New File] 34
 - [Polygon Properties] 44
 - [Preferences] 36
 - [Save As] 67
 - [Select Base Font] 66
 - [Select Stroke Font] 40
 - Shape Properties 43
 - [Straight Line Properties] 45
 - [Stroke Font Table] 70
 - [Symbol] 51
 - [Template Properties] 48
 - [Text Box Properties] 46
 - [Text String Properties] 42, 43
 - [Direction] command 40
 - Doesn't function
 - Dr. Engrave 55
 - Engraving machine 55
 - Dr.Engrave file 74
- E**
- [Edit] menu 37, 68
 - [Edit Stroke...] command 41
 - [Edit Template] command 52
 - Engraving
 - Cancel 12
 - Depth 18
 - Engraving at one time 19, 22
 - Origin 18
 - Ready 21, 23
 - Specified plate 25
 - Start 21, 23
 - Engraving area 9, 20
 - Enter the text 20, 23
 - Error messages 56, 73
 - [Exit] command 36, 67
 - Extraction of clear outlines 30, 31
- F**
- Feed rate 21, 24
 - [File] menu 34, 66
 - [Fill] command 48
 - [Fill Setup] dialog box 48
 - [Fit to Screen] command 38, 69
 - Flat-drag engraving 48
 - [Font...] command 40
 - [Font Select] dialog box 40
 - [Format] menu 40
- G**
- Gradations 30, 31, 74
 - Grid 28, 39
 - [Grid] command 69
 - [Grid Setup...] command 39, 69
 - [Grid Setup] dialog box 39, 69
 - [Guide Lines] command 39

-
- H**
- [Help] menu 53, 72
- I**
- "XXXXXX Illegal Font Select." 55
 - [Import...] command 34
 - [Import Text...] command 35
 - Importing a CSV file 25, 35
 - Importing a text file 25
 - Importing an object 30
 - Importing bitmap data 31
 - Indicate 74
 - Importing CSV file 25, 35
 - [Insert Vertex] command 50
- L**
- [Layout] menu 52
 - [Layout Info.] command 38
 - [Layout Setup] command 52
 - [Layout Setup] dialog box 20, 23, 52
 - [Line Alignment] command 40
 - [Line Spacing] command 40
- M**
- [Make Stroke...] command 40
 - Maximize button 7, 59
 - Measurement system 29
 - Menu bar 7, 59
 - Minimize button 7, 59
 - [Mirror] command 49
 - [Move Shape...] command 49
 - [Move To Back] command 53
 - [Move To Front] command 52
 - [Moving a Shape] dialog box 49
 - Multiple plates 19, 22
- N**
- Names and functions 7
 - [New] command 34, 66
 - [New File] dialog box 34
 - "Not enough memory." 55
- O**
- Object 7, 14, 74
 - Change the size 14, 26
 - Copy 15
 - Delete 15
 - Import 30
 - Move 14
 - Rotate 14
 - Select 14
 - Slant 15
 - [Object Info.] command 38
 - Object information bar 7, 59
 - [Open...] command 34
 - [Open] dialog box 66
 - Operating environment 5
 - Operation procedures 8, 60
 - Origin 7, 18
 - Overview 5
- P**
- Paste 37, 68
 - [Paste] command 37, 68
 - Pasting a graphic 28
 - [Polygon Properties] dialog box 44
 - Polyline
 - Changing size 64
 - Drawing 64
 - Moving 63
 - Selecting 63
 - Popup menu 7, 59
 - Port 55
 - [Preferences...] command 36
 - [Preferences] dialog box 36
 - Preview 35
 - [Print...] command 35
 - [Print Preview] command 35
 - [Print Setup...] command 35
 - [Properties...] command
 - [Format] - [Properties...] 41
 - [Shape] - [Properties...] 42
- R**
- Re-engraving 25
 - [Redo] command 37, 68
 - [Regenerate Stroke Character] command 70
 - Resolution 30, 31, 74
 - [Return to Layout] command 52
- S**
- [Save] command 34
 - [Save As...] command 34
 - [Save As] dialog box 67
 - [Save As...] command 67
 - [Save] command 67
 - Scanner 30, 35
 - [Select All] command 37, 68
 - [Select Base Font] dialog box 66
 - [Select Source] command 35
 - [Select Stroke Font] dialog box 40
 - [Server Vertex] command 50
 - SFEdit 41
 - SFEdit file 74
 - [Shape] menu 42, 70
 - [Shape Properties] dialog box 43
 - [Show Grid] command 39, 69
 - Snap point 28
 - [Snap To Grid] command 39, 69
 - [Snap to Vertex] command 50, 71
 - Speed 21, 24
 - Starting the software 6
 - Status bar 7, 59
 - [Status Bar] command 38
 - Straight line
 - Drawing 64
 - Moving 63
 - Selecting 63
 - [Straight Line Properties] dialog box 45
 - [Stroke Character Batch Generate...] command 71
 - Stroke characters 26, 41, 56, 57, 59
 - [Stroke Font Table] dialog box 70
 - [Style] command 40

Symbol	
Import	29
Register	29
[Symbol] dialog box	51
[Symbols] command	51

T

Template	19, 22
[Template Properties] dialog box	19, 22, 48
[Text Box Properties] dialog box	46
Text entry box	65
[Text String Properties] dialog box	42, 43
Title bar	7, 59
Toolbar	7, 33, 59
[Toolbar] command	38, 69
Toolbar buttons	33, 65
TrueType font	5, 74
TrueType fonts	10
TWAIN	30, 35

U

[Undo] command	37, 68
"Unexpected file format."	56
Using symbols	29

V

V Cut	52
Vector data	28, 74
Vertex	
Adding	62
Deleting	63
Moving	62
Selecting	62
Vertex of a polygon (polyline)	
Add	16
Delete	16
Move	16
Select	15
Vertical/horizontal aspect	26, 42, 44, 47
Vertices of a polygon (polyline)	
Selecting all	16
Selecting multiple	15
[View] menu	38, 69

W

Windows BMP (bitmap)	74
----------------------------	----

X

"XXXXXX Illegal Font Select"	55
------------------------------------	----

Z

[Zoom In] command	38, 69
[Zoom Out] command	38, 69

